

Sun Odyssey

469



S U M M A R Y

- > SPECIFICATIONS
- > KEY POINTS
- > EXTERIOR
- > INTERIOR
- > SAILS
- > 360 DOCKING
- > CONSTRUCTION
- > UPHOLSTERY
- > ELECTRONIC PACKAGES



JEANNEAU



PROVISIONAL TECHNICAL INFORMATION

Overall length: 14,05 m / 46' 1"
 Hull length: 13,65 m / 44' 9"
 Waterline length: 12,54 m / 41' 1"
 Beam: 4,49 m / 14' 8"

Displacement: 10.809 kg / 23.830 lbs
 Standard keel draft: 2,24 m / 7' 4"
 Shoal keel draft: 1,65 m / 5' 4"

Cabins: 3 / 4
 Berths: 6 / 8 +2

Power engine: Yanmar 54 Hp / 40 Kw
 Fuel capacity: 240 l / 63 US gal
 Water capacity: 615 l / 163 US gal
 Fridge capacity: 255 l / 67 US gal

Sail area:
 - Standard 96 m² / 1 033 Sq ft

CE Category: A10 / B11 / C14 Pers
 Designers: Philippe Briand - Jeanneau Design

VERSIONS • LAYOUTS

Compatible 360 Docking - POD90

Fixed keel version
 Shoal draft version

3 cabins / 2 heads
 3 cabins / 3 heads
 4 cabins / 4 heads

Offshore cruiser, elegant and very comfortable.

EXTERIOR

Comfort and performance for passagemaking:

- Powerful, balanced and modern hull designed by Philippe Briand, that combines a long waterline length and a hard chine for speed and comfort at sea.
- Sleek deck lines, safe and ergonomic with flush hatches and integrated running rigging.
- Sail plan with a high aspect ratio. Multiple choices including: self-tacking jib, large, overlapping genoa, Code 0, furling mast, etc...
- Safe and ergonomic cockpit with lines led back to helm stations.

Relaxation and aesthetics:

- Large cockpit with full-function table
- Fold-down transom for easy access to the sea and sundeck
- Sleek deck with curved windows, flush panels and integrated running rigging

INTERIOR

Light, volume and ventilation:

- A multitude of ports and hatches for ventilation and light
- 3 distinct zones in the saloon designed to allow each to be used independently without constricting movement throughout the interior
- Light and luxury down below with solid wood, mat varnish, polished stainless steel, leather and a full selection of interior fabrics.

Lots of features:

- All the features of the larger Sun Odysseys concentrated on the same boat
- Plenty of choices available: Different interior layouts, sail plans, keel and fabrics allow each owner a high level of personalisation



HULL AND KEEL: Modern and balanced

- **Philippe Briand design**
- **Deep keel** (2.24m) or shoal (1,65m)
- **Hard chine on hull** creates stability and enhances interior volume
- **Long water line** provides performance under sail and power
- **Moderate freeboard** lends a beautiful and sleek look to the hull along with the 8 hull ports and hard chine.



DECK AND COCKPIT: Liveability, comfort and safety

- **Twin helm steering moved far aft**, keeps the cockpit clear and gives easy access to the transom
- **Harken deck hardware:** winches, blocks, tracks designed to make sail handling easy from the helm
- **Easy access to the sea** thanks to a wide drop-down aft platform.
- **Large cockpit table** with storage, lighting, icebox, place for instruments and the joystick of the optional 360 Docking system.
- **Flush hatches and integrated running rigging** gives the deck a sleek look and makes movements onboard safer.
- **Lots of storage:** 2 lateral lockers, 2 large lockers under the helm stations, 1 large locker for the optional generator. Forward sail locker and deep anchor locker.

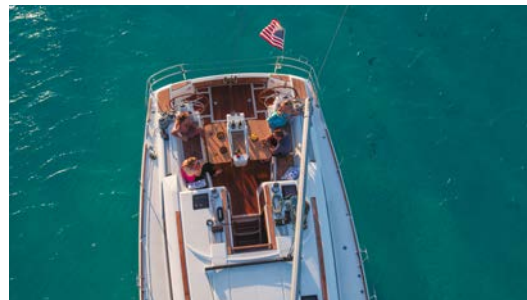

DECK

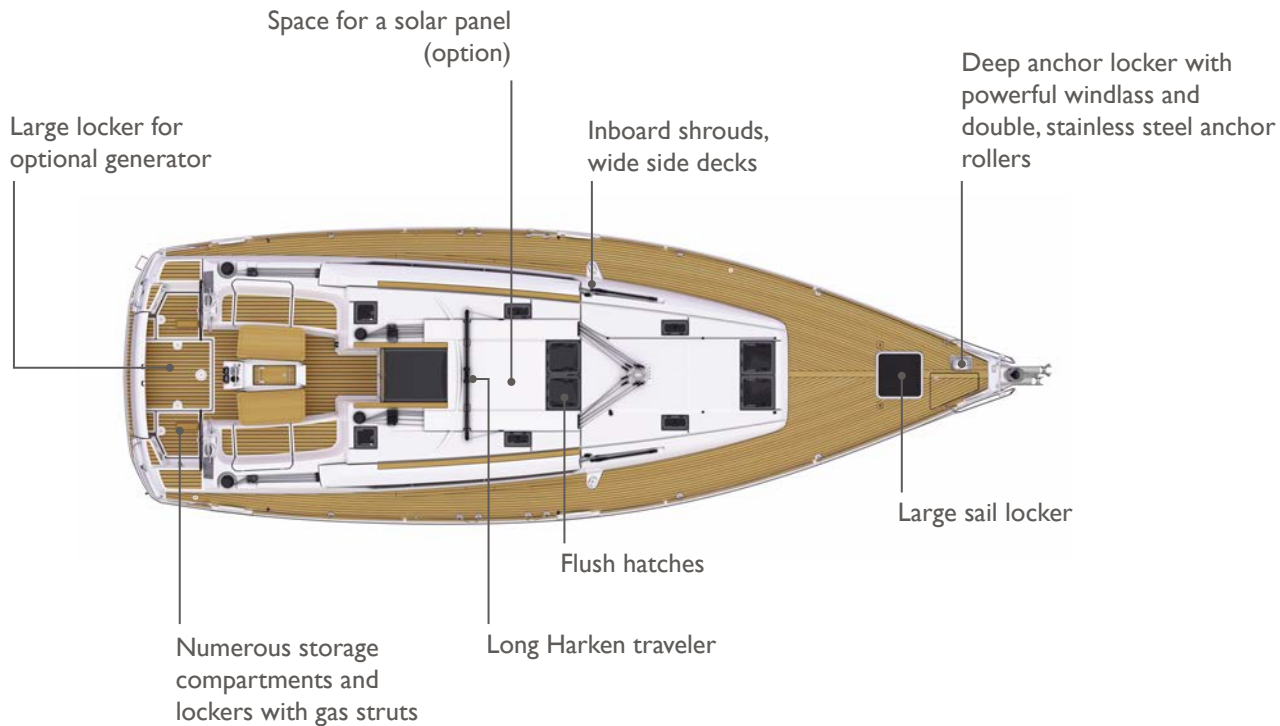

DECK (continued)



Additional opening port in each aft cabin (Trim Level)

Companionway hatch with hinged double doors



Harken deck hardware

Wide drop down platform

Flush hatches and integrated running rigging

All sheets lead aft with optional Harken «Rewind» winches available



Twin helm stations with optional GPS screens

Large table with storage



Very comfortable helm position without any interference from the backstays

INTERIOR: Space, style and comfort

All the attributes of the larger Sun Odyssey come together on this yacht:

- **Spacious interior** with choice of 3 layouts (from 3 to 4 cabins).
- **An exceptional layout in the saloon**, separate zones for living aboard plenty of functional details
- **Luxurious materials**, set off by all LED lighting
- **Numerous and practical storage lockers**, for offshore cruising with friends and family.
- **Light and ventilation:** 8 hull ports, long deckhouse windows, lots of opening ports and flush hatches.
- **Personalisation:** Choice of different fabrics, floorboards and a full list of options allow you to chose the combination that is right for you.



INTERIOR LAYOUTS

3 cabins version / 2 heads



4 cabins version / 4 heads



3 cabins version / 3 heads



SALOON

U-shaped saloon holds 8 people without interfering with the other zones aboard. View of the sea and very large table.



Large, fixed hull ports

Several upholstery choices, including the possibility to have differently coloured backrest inserts

Folding deluxe table (optional) with leather-lined central plateau with storage

LED indirect lighting under kickboard (option)



Large storage compartments under the seating, easy access to a storage compartment with gas lifter. Bar cabinet and storage basket



Optional seating allows 8 people to be seated around the table. Chairs are delivered with a tie-down system

GALLEY (3 cabins version / 2 heads)

Large, functional L galley makes cooking easy at sea or at anchor.

Space for optional
microwave

175L Fridge with optional vertical door,
80L freezer



Easy access to upper
cabinets with fiddles

Spice rack

3-burner stove with thermostatically
controlled oven (option)

Utensil drawer

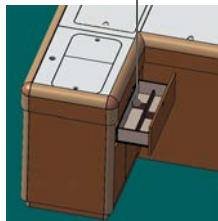

GALLEY (3 cabins / 3 heads and 4 cabins / 4 heads version)

Long galley with multiple, large storage compartments

Multiple, large storage compartments



Fixed bench seat provides additional seating and bracing position for galley (option)



Space for optional microwave

3-burner stove with thermostatically controlled oven

Fridge compartment (175L),
freezer compartment (80L)

CHART TABLE STARBOARD : (3 cabins version, 2 heads)

Relaxation zone with view of the sea and of the TV, central bar cabinet, plush seating with armrests.

Option 1: display of GPS information on the TV screen



Option 2: ability to view and control the GPS using a smartphone or tablette



Electrical panels 12V placed behind a drop-down door

2 seats with backrest inserts

Book storage behind the backrest



Large, leatherette-covered navigation station that is designed for use with a laptop computer and can convert into a sofa



CHART TABLE PORTSIDE (3 cabins / 3 heads and 4 cabins / 4 heads version)

Very large desk with lots of dedicated storage compartments, full integration of the latest entertainment and navigation technologies



Leatherette-lined desk with space for a laptop computer

Electrical panels placed behind a drop-down door, location of optional electrical panels



Storage niche under the nav table

Option 1: display of GPS information on the TV screen



Option 2: ability to view and control the GPS using a smartphone or tablette



FORWARD OWNER'S CABIN:

Spacious head compartment with fully separate shower, overhanging berth, lots of storage and desk.

Very large head compartment with fully-separate shower, moulded countertop and sink, plenty of storage



2 FORWARD CABINS

With large private head compartment, large island berth, hanging lockers and desk/vanity



Private head compartments



Open shelf down the side of the hull

Large hanging locker in each cabin

Numerous storage options

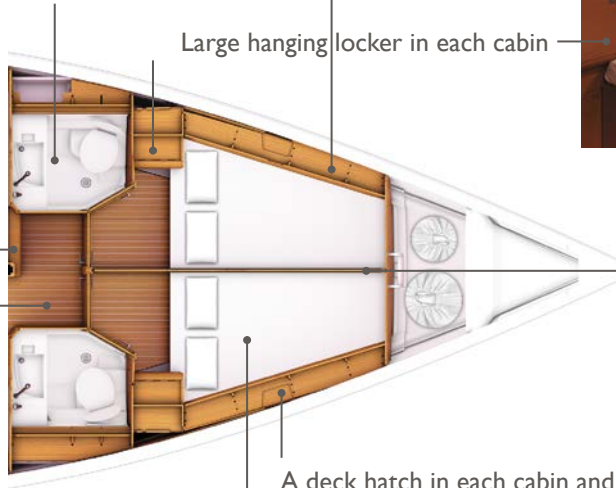

Removable bulkhead with dedicated storage under the bed

A deck hatch in each cabin and head compartment

Double berth as large as that on the SO 509

Access hallway to forward cabins visually lengthens the saloon



AFT CABINS

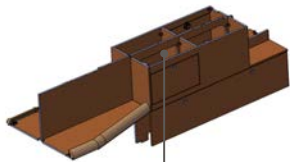

Up to 5 ports and hatches : hull port, one or two* opening cockpit ports deck hatch and side window in each cabin

Storage between the two aft cabins



Indirect lighting

Cabinets along hull sides

Hanging locker

Head compartment with separate shower, moulded countertop and sink, WC and numerous storage compartments



Wet hanging locker

* Optional second cockpit port

SAIL AND RIG PLANS: Sails for every sailor

Select the sail plan that best fits your style :

- **High aspect ratio rig** for maximum performance while limiting the loads on the sheets.
- **Inboard shrouds and genoa tracks** allow better trim of the standard or performance sails and easy circulation on the side decks
- Choice of self-tacking jib, Performance sails in Mylar/taffeta, fully-battened or furling mainsail...
- **Code 0** offered as an option for sailing in light wind conditions

SPECIFICATIONS

BATTENED MAINSAIL:

- Dacron®
- Horizontal panels
- Stainless steel eyes
- UV-stabilised thread
- Draft stripe
- Radial reinforcements
- Adjustable leech line
- Loose-footed
- Full batten
- 2 reef points each with singleline reefing system. (Third classic reef point)

• Area : 49,6 m²



SHORT OVERLAPPING FURLING GENOA (106%) :

- Dacron®
- Horizontal panels
- UV-stabilised thread
- Webbing strap at head
- Bolt-rope for furler
- Anti-UV protection on foot and leech
- Draft stripe
- Webbing strap at tack
- Reefing marks
- Adjustable leech line

• Area : 46,5 m²



ADVANTAGES

- High-aspect rig for maximum performance
- Easy to handle sail plan
- Versatile and balanced sail plan at all sailing angles

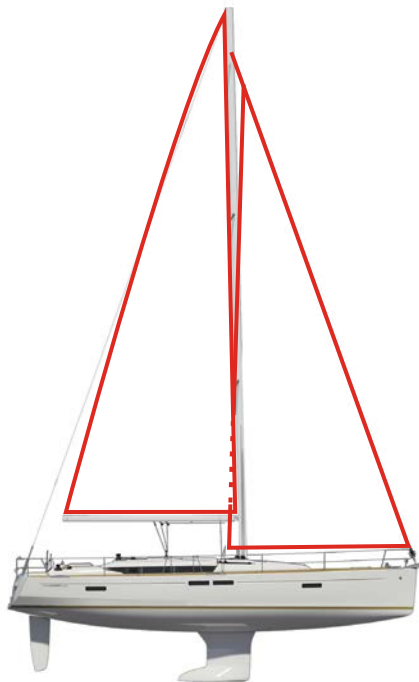

I = 17,20 m / 56'4"
J = 5,66 m / 18'6"
P = 16,62 m / 54'5"
E = 5,10 m / 16'8"

MAINSAILS

PERFORMANCE MAINSAIL : 49,6 m²

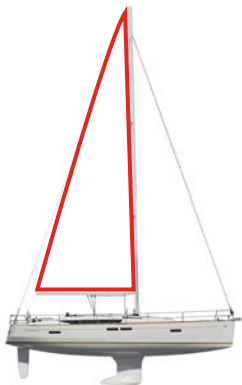

FURLING MAINSAIL : 38 m²

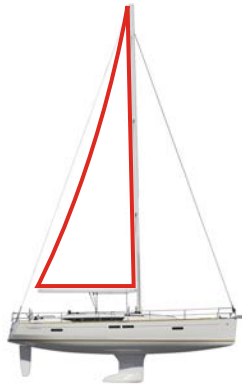

FORESAILS

**PERFORMANCE GENOA 106% :
46,6 m²**



SELF-TACKING JIB : 38,4 m²



**PERFORMANCE GENOA 140% :
60,3 m²**



CODE 0 : 84,4 m²

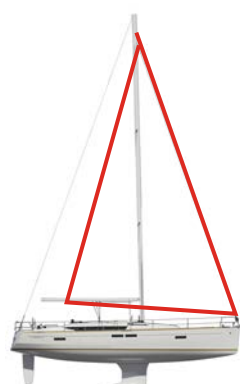

SPECIFICATIONS

BATTENED MAINSAIL

full-batten Performance :

- Triradial cut
- Mylar/taffeta X-Grid fabric in grey colour
- Stainless steel eyes
- UV-stabilised thread
- Draft stripe
- Radial reinforcements
- Adjustable leech line
- Loose-footed
- Fibreglass battens
- 2 reef points each with singleline reefing system. (Third classic reef point)
- Replaces the standard mainsail
- **Area : 49,6 m²**

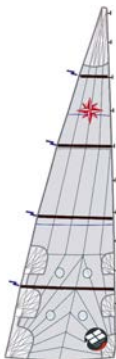

ADVANTAGES

- High-end sail cloth material means less stretch and better performance
- Powerful sail plan in light winds
- Tri radial cut ensures better sail shape and improved resistance to wear.



PERFORMANCE SAILS : MYLAR TAFFETA X-GRID

Working in collaboration with Dimension-Polyant and Technique Voiles, Jeanneau has developed a new Mylar Taffeta X-Grid fabric for the Performance range.

The triradial construction of the sail contributes to superior shape holding, but other forces can act on the individual panels. By using a specially-designed X-Grid[®] of fibres angled at 6° laminated into the fabric, better bias control can be achieved which makes the sail more resistant to deformation and aging.

The performance of these new fabrics provides a more stable sail cloth that is lighter, easier to handle, with better shape control over time.

These new Performance sails are easily recognisable; they include a taffeta laminate that is light grey that gives them a very “hi-tech” look.

- 1 - Protective taffeta
- 2 - Polyester film
- 3 - X-Grid[®] fibres
- 4 - Polyester scrim

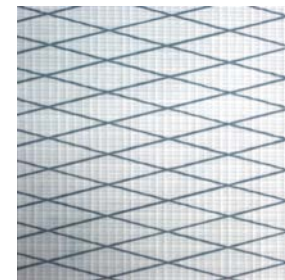

SPECIFICATIONS

FURLING MAINSAIL :

- Dacron®
- Horizontal panels
- UV-stabilised thread
- Radial reinforcements
- Draft stripe
- Adjustable leech line
- UV protection on clew
- Replaces the standard mainsail
- Included in furling mast option

• **Area : 38 m²**



ADVANTAGES

- Easy handling
- Quick furling of the sail
- Easy reefing
- Same height as the classic mainsail
- Compatible with any of the foresail options



SPECIFICATIONS

FURLING GENOA

106% Performance :

- Mylar/taffeta X-Grid fabric in grey colour
- Triradial cut
- UV-stabilised thread
- Webbing strap at head
- Bolt-rope for furler
- Anti-UV protection on foot and leech
- Radial reinforcements
- Foam luff
- Draft stripe
- Webbing strap at tack
- Reefing marks
- Adjustable leech line
- Replaces the standard genoa
- **Area : 46,6 m²**



ADVANTAGES

- High-end sail cloth material means less stretch and better performance
- Balanced sail plan for all sailing angles
- Easy to use in all conditions
- Compatible with Smart Tacking

PERFORMANCE SAILS : MYLAR TAFFETA X-GRID

Working in collaboration with Dimension-Polyant and Technique Voiles, Jeanneau has developed a new Mylar Taffeta X-Grid fabric for the Performance range.

The triradial construction of the sail contributes to superior shape holding, but other forces can act on the individual panels. By using a specially-designed X-Grid[®] of fibres angled at 6° laminated into the fabric, better bias control can be achieved which makes the sail more resistant to deformation and aging.

The performance of these new fabrics provides a more stable sail cloth that is lighter, easier to handle, with better shape control over time.

These new Performance sails are easily recognisable; they include a taffeta laminate that is light grey that gives them a very “hi-tech” look.

- 1 - Protective taffeta
- 2 - Polyester film
- 3 - X-Grid[®] fibres
- 4 - Polyester scrim

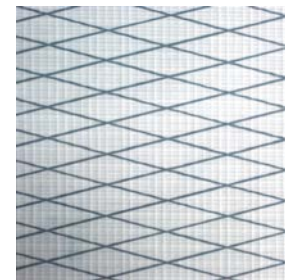

SPECIFICATIONS

FURLING GENOA

140% Performance :

- Mylar/taffeta X-Grid fabric in grey colour
- Triradial cut
- UV-stabilised thread
- Webbing strap at head
- Bolt-rope for furler
- Anti-UV protection on foot and leech
- Radial reinforcements
- Foam luff
- Draft stripe
- Webbing strap at tack
- Reefing marks
- Adjustable leech line
- Replaces the standard genoa
- Requires deck hardware for large overlapping genoa
- **Area : 60,3 m²**



ADVANTAGES

- High-end sail cloth material means less stretch and better performance
- Maximum sail area
- Powerful sail plan in light winds
- Tri radial cut ensures better sail shape and improved resistance to wear.

PERFORMANCE SAILS : MYLAR TAFFETA X-GRID

Working in collaboration with Dimension-Polyant and Technique Voiles, Jeanneau has developed a new Mylar Taffeta X-Grid fabric for the Performance range.

The triradial construction of the sail contributes to superior shape holding, but other forces can act on the individual panels. By using a specially-designed X-Grid[®] of fibres angled at 6° laminated into the fabric, better bias control can be achieved which makes the sail more resistant to deformation and aging.

The performance of these new fabrics provides a more stable sail cloth that is lighter, easier to handle, with better shape control over time.

These new Performance sails are easily recognisable; they include a taffeta laminate that is light grey that gives them a very “hi-tech” look.

- 1 - Protective taffeta
- 2 - Polyester film
- 3 - X-Grid[®] fibres
- 4 - Polyester scrim

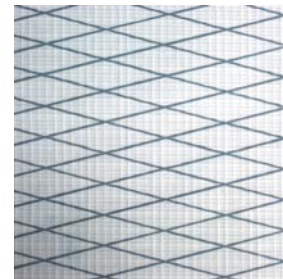

SPECIFICATIONS

SELF-TACKING FURLING JIB :

- Mylar/taffeta X-Grid fabric in grey colour
- Triradial cut
- UV-stabilised thread
- Webbing strap at head
- Bolt-rope for furler
- Anti-UV protection on foot and leech
- Draft stripe
- Radial reinforcements
- Webbing strap at tack
- Adjustable sheet attachment
- Adjustable leech line
- Replaces the standard genoa
- Requires deck hardware for self-tacking jib

• **Area : 38,4 m²**



ADVANTAGES

- Hands-free tacking
- Great up-wind performance
- Perfect for short-handed sailing

PERFORMANCE SAILS : MYLAR TAFFETA X-GRID

Working in collaboration with Dimension-Polyant and Technique Voiles, Jeanneau has developed a new Mylar Taffeta X-Grid fabric for the Performance range.

The triradial construction of the sail contributes to superior shape holding, but other forces can act on the individual panels. By using a specially-designed X-Grid[®] of fibres angled at 6° laminated into the fabric, better bias control can be achieved which makes the sail more resistant to deformation and aging.

The performance of these new fabrics provides a more stable sail cloth that is lighter, easier to handle, with better shape control over time.

These new Performance sails are easily recognisable; they include a taffeta laminate that is light grey that gives them a very “hi-tech” look.

- 1 - Protective taffeta
- 2 - Polyester film
- 3 - X-Grid[®] fibres
- 4 - Polyester scrim

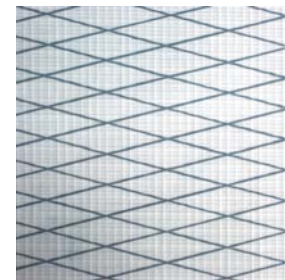

SPECIFICATIONS

CODE 0

Selden continuous line furler :

- Laminate Mylar/Aramid X-Grid fabric in light grey
- Triradial cut
- Anti twist luff cord
- UV-stabilised thread
- Straps for sheet attachment
- Adjustable leech and foot lines
- Requires rigging for asymmetrical spinnaker / Code 0
- **Area : 84,4 m²**



ADVANTAGES

- A light wind sail designed for use between 60° and 120°
- Continue to sail when others have given up and turned on the motor
- Continuous line furler allows easy deployment and furling from the cockpit
- Ideal addition to boats with small overlapping jibs and self-tacking jibs



CODE 0: MYLAR ARAMID X-GRID

For the development of the new Code 0 sails on a continuous line furler, Jeanneau selected a sail cloth that is perfectly adapted for use in light airs. Highly resistant, light weight and able to be furled, the Mylar Aramid X-Grid has a light grey finish that is translucent.

Unidirectional Aramid fibres, vacuum-bagged together between two polyester films, provide an unequalled resistance to weight ratio. This ultra light sail is easy to handle and fills with the slightest puff of wind. Adding the X-Grid® polyester fibres at a 6° angle provides excellent bias control in all directions and improves sail shaping, as well as, resistance to tearing.

Lastly, a taffeta is added to the external laminate of the sail cloth to protect the sail from ultraviolet light and wear during furling or storage.

The Code 0 sails from Jeanneau integrate these high-performance materials to meet the exacting demands of our owners. In addition to these high-end materials, the look of these sails sets Jeanneau apart.

- 1 - Polyester film
- 2 - X-Grid® fibres
- 3 - Unidirectional Aramid fibres
- 4 - Protective taffeta

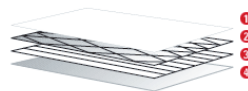

SO469 - 07/2014



WHAT IS 360 DOCKING?

- The 360 Docking system is a revolutionary propulsion system developed by Jeanneau and ZF Marine. This unique system allows easy and safe manoeuvring of a sailboat in tight quarters via a joystick mounted in the cockpit.
- 360 Docking: Docking made easy!

DIFFERENT MODELS AVAILABLE:

- The 360 Docking system has been developed in several different sizes in order to adapt it to sailboats from 40 to 57':

POD60 : 38' – 42'
POD90 : 43' – 49'
POD120 : 50' – 54'
POD180 : 55' – 58'



HOW DOES IT WORK?

- The concept is simple: the engine is coupled with a pivoting sail drive, capable of rotating 360°.
- The joystick transmits the commands to a control box, which uses the autopilot to lock the helm. Then, a simple movement of the joystick controls the orientation and the thrust of the pod, as well as the bowthruster when moving sideways.
- You can vary throttle power with the joystick. You can also combine movements, like rotation and forward moment to turn and move forward at the same time.



> Forward movement: saildrive facing aft



> Sideways movement: saildrive turns 90° and activates bowthruster



> Aft movement: saildrive turns 180°



> Rotation: saildrive turns 90° to pivot boat around axis

UNIQUE FEATURES OF THE SYSTEM:

- **Sideway manoeuvring:** manoeuvre in ways never before possible
- **Easy and powerful rotation:** using the saildrive leg at 90°, the boat can be rotated easily and quickly using the main engine, which is much more powerful than the bowthruster.
- **Very powerful reverse gear:** both with throttle and joystick due to the fact that the sail drive turns around 180° so that the propeller is always facing “forward.” This also means that folding propellers work very well with the system.
- **Ability to stop and adapt:** with the ability to move in any direction while applying variable power means that normal steerageway is not necessary for manoeuvring. The boat can be stopped, repositioned and moved at the touch of the joystick without having to do every manoeuvre at higher speeds. Safety and piece of mind.
- **Better visibility when manoeuvring:** most of our boats allow the helmsman to be standing when using the joystick so that he or she has a better view of the dock than if reaching down to use a traditionally-placed throttle control.
- **Comfort of an electronic throttle:** the regular throttle on the boat is electronic. This makes it easy to use.
- **Gearbox longevity:** since there is no reverse gear, the 360 Docking gearbox does not include any of the conical gears that typically wear out in standard gearboxes.

FAQ :

- **Is this system available from other boat manufacturers?**
The partnership between ZF Marine and the Groupe Beneteau means that only Jeanneau and Beneteau boats have access to this technology. Our exclusive agreement extends into 2014.
- **Can I use a folding propeller?**
Yes, folding propellers work very well with the system because the main drawback of folding propellers is that they don't work in reverse, but since the drive always rotates to face forward to the direction you want to go, the folding propeller works efficiently, even in reverse. We recommend Flex-o-Fold propellers.
- **Can I use a feathering (Max-Prop) propeller?**
No, there is no need to use a feathering propeller, as they are designed to rotate the blades when in reverse, so there is no clear advantage to installing these on a drive system with no reverse gear.
- **If, for some reason, there is a failure, can I rotate the saildrive manually?**
Yes, it can be rotated back into position manually in case of failure.



PRISMA PROCESS



Leader in vacuum bagging technology for the construction of racing boats, JTA developed an resin injection process applicable to the construction of cruising boats. By using advanced engineering, precisely positioned layers of glass fabric and mat and specially developed core materials, Jeanneau is able to mould a deck to exacting tolerances.

Jeanneau's leadership in this domain gives it a substantial advantage over its competitors and ensures unequalled quality to the customer.

This 21st century technology allows Jeanneau to manufacture complex fibreglass parts with:

- Perfect finish on both sides (no need for a counter mould)
- Reduced weight (providing the sailboat better stability/performance)
- Increased strength and rigidity of the piece (quality of lay-up)
- Reduction by 90% of VOC emissions (environmentally-friendly)
- Optimum working conditions for the production team (no contact with resins/catalysts)
- High quality parts (precise control of gelcoat, core materials and resin injection)

The deck of the Jeanneau 53 is the largest mass-produced injection fibreglass part in the world.

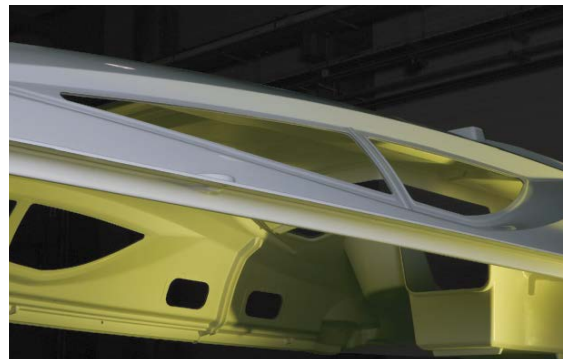

COUNTER-MOULDING

3rd generation hull structure

Jeanneau has long been known for strong and seaworthy boats. Today the technology of boatbuilding has evolved, but our commitment to this tradition has not wavered. The Jeanneau 3rd Generation Hull Structure combines the latest in fiberglass technology with modern yacht design to deliver a structural reinforcement perfectly adapted to the demands of the offshore sailor.

- ❶ High-load zones cut-out for access to the hull
- ❷ Integrated repair area at aft end of keel
- ❸ Structure is precisely placed in the hull
- ❹ Glued and relaminated to the hull for strength
- ❺ Acts as a support for the floorboards
- ❻ Keel bolts located near vertical members and through counter mould and hull
- ❼ Limber holes at hull level for efficient drainage
- ❽ Counter mould remains below level of floorboards and is not visible

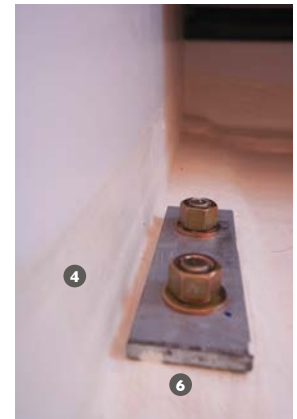

ALPI WOOD - FINETEAKE

SALES POINTS:

Environmental:

- Ayous (Triplochiton scleroxylon - Sterculiacées) trees in managed forests of indigenous hardwoods are selected and cut, with a constant care given towards long term preservation of natural resources.
- Teak and other soft rainforest woods often come from geopolitically sensitive regions and are not managed in a sustainable way.

Quality:

- These ALPI wood panels are substantially more expensive and reliable than standard marine plywood. They are used by top of the line furniture manufacturers, as well as many exclusive super-yacht builders (for example Azimut and Ferretti only use ALPI wood).
- Consistency of finish and colors throughout the boat.
- Elimination of “defects” in wood panels.

Durability:

- Harder finish that is more resistant to humidity
- Better resistance to UV
- Easier repairs as veneer is tinted through and through so clear varnishes can be used



Ambiance "WHITE GOLD"

SALOON



BACKRESTS & SEATS

▶ White Gold



UPHOLSTERY leather/
leatherette ▶ Chocolat



FLOOR ▶ Std: Light oak laminate



▶ Option:
Laminate teak



▶ Option :
Dark oak laminate



Infill cushion for convertible berth in White Gold

CABINS

SEATS

▶ PVC Mediterraneo
Old White



BEDS

▶ Premium mattress

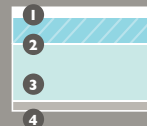

1- Removable mattress cover fabric with Ultra-Fresh® is anti-microbial, anti-bacterial and non-allergenic

2- Top: 40mm of High-Resilience foam

3- Base: 80mm of high-density polyether foam

4- Breathable fabric

Ambiance "MEDITERRANEO"

SALOON



BACKRESTS & SEATS

▶ PVC Mediterraneo Old White



UPHOLSTERY leather/
leatherette ▶ Chocolat



FLOOR
▶ Std: Light oak laminate



▶ Option:
Laminate teak



▶ Option :
Dark oak laminate

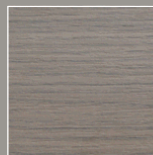

Infill cushion for convertible berth in White Gold

CABINS

SEATS

▶ PVC Mediterraneo
Old White



BEDS

▶ Premium mattress

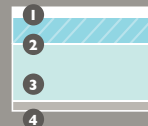

1- Removable mattress cover fabric with Ultra-Fresh® is anti-microbial, anti-bacterial and non-allergenic

2- Top: 40mm of High-Resilience foam

3- Base: 80mm of high-density polyether foam

4- Breathable fabric

Ambiance "LOFT"

SALOON



UPHOLSTERY leather/
leatherette ▶ *Chocolat*



FLOOR
▶ *Std: Light oak laminate*



▶ *Option:*
Laminate teak



BACKRESTS INSERTS

▶ *Mega chinchilla*



SEATS

▶ *Tudor graphite*

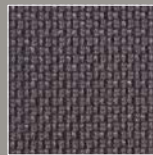

▶ *Option :*
Dark oak laminate



CABINS

SEATS

▶ *PVC Mediterraneo*
Old White



BEDS

▶ *Premium mattress*

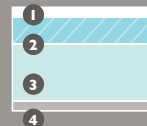

1- Removable mattress cover fabric with Ultra-Fresh® is anti-microbial, anti-bacterial and non-allergenic

2- Top: 40mm of High-Resilience foam

3- Base: 80mm of high-density polyether foam

4- Breathable fabric

Ambiance "CAYENNE"

SALOON



BACKRESTS INSERTS

▶ Tudor chutney



SEATS

▶ PVC Mediterraneo Old White



UPHOLSTERY leather/
leatherette ▶ Chocolat



FLOOR

▶ Std: Light oak laminate



▶ Option:
Laminate teak



▶ Option :
Dark oak laminate

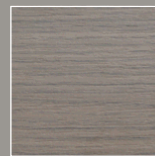

CABINS

SEATS

▶ PVC Mediterraneo
Old White



BEDS

▶ Premium mattress

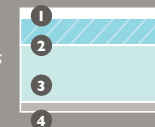

1- Removable mattress cover fabric with Ultra-Fresh® is anti-microbial, anti-bacterial and non-allergenic

2- Top: 40mm of High-Resilience foam

3- Base: 80mm of high-density polyether foam

4- Breathable fabric

Ambiance "METROM NATUREL"

SALOON



UPHOLSTERY leather/
leatherette ▶ *Chocolat*



FLOOR
▶ *Std: Light oak laminate*



▶ *Option:*
Laminate teak



▶ *Option :*
Dark oak laminate



BACKRESTS INSERTS

▶ *Cortina Naturel*



SEATS

▶ *White Gold*



CABINS

SEATS

▶ *PVC Mediterraneo*
Old White



BEDS

▶ *Premium mattress*

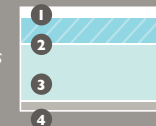

1- Removable mattress cover fabric with Ultra-Fresh® is anti-microbial, anti-bacterial and non-allergenic

2- Top: 40mm of High-Resilience foam

3- Base: 80mm of high-density polyether foam

4- Breathable fabric

Infill cushion for convertible berth in White Gold

Ambiance "LEATHER"

SALOON



FLOOR

▶ Std: Light oak laminate



▶ Option:
Laminate teak



▶ Option :
Dark oak laminate

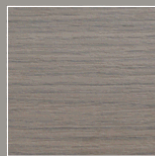

CABINS

SEATS

▶ PVC *Mediterrano Old White*



BEDS

▶ *Premium mattress*

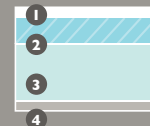

- 1- Removable mattress cover fabric with Ultra-Fresh® is anti-microbial, anti-bacterial and non-allergenic
- 2- Top: 40mm of High-Resilience foam
- 3- Base: 80mm of high-density polyether foam
- 4- Breathable fabric

EXTERIOR UPHOLSTERY

SPRAYHOOD PROTECTION BIMINI / LAZY BAG



► Sunbrella taupe



COCKPIT CUSHIONS



► Sunbrella sling taupe



Raymarine

Electronic Pack

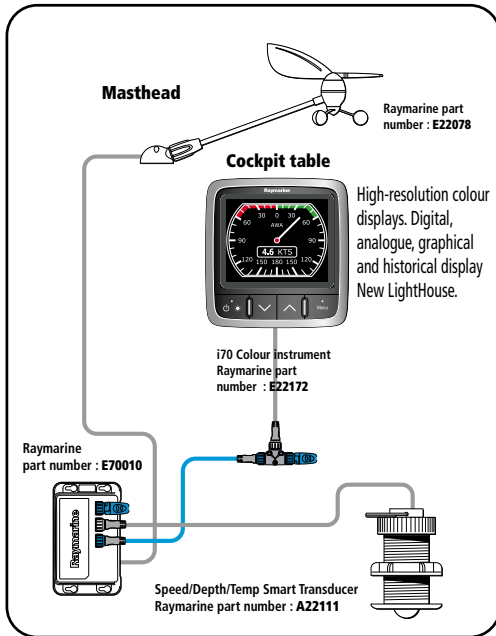

OPTIONS 1/2

Cockpit port



2 x e95 Multifunction Touchscreen Display WVGA

Touchscreen Multifunction display,
1 x Silver or Lighthouse Vector US supplied
2 x Raymarine part number : **E70021**



Cockpit starboard



e95 Multifunction Touchscreen Display WVGA Cockpit starboard

Touchscreen Multifunction display,
Silver or Lighthouse Vector US supplied
Raymarine part number : **E70021**



SmartController Wireless remote



Raymarine part number:
E15023

Raymarine

OPTIONS 2/2

Optional inboard autopilot - Cockpit starboard



p70 Colour Autopilot Control Head
Raymarine part number: **E12166**

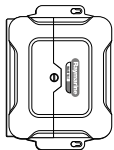

Compass with built-in Rate Gyro Gyro EV-1, power unit ACU-400 12/24 V F, rudder reference transducer. Raymarine part numbers: **E70096 + E70100**

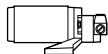

Digital Radar radome antenna 48 NM 18"



DIGITAL radar antenna supplied with antenna cable and mast bracket.
Raymarine part number: **E92130**

Fix mounted DSC VHF Radio & Class B AIS transceiver (Works only if a e series screen is fitted)



AIS650 class B AIS transceiver
Receive and transmit AIS navigation status information on e series. Use the VHF antenna.
Raymarine part number : **E32158**

Image of the GPS display on the TV in the main saloon



2 way control between the Multifunction display and your mobile device.
Application to download from the App Store, Google Play or the Amazon Store.
Require a Smartphone or a tablet not supplied.



VHF DCS Ray55E
Raymarine part number : **E43037**
Compatible with a second station handset (Not supplied)

PC interface

SeaTalking to NMEA0183 interface bridge for PC.

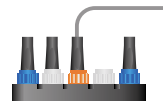



July 2014 - Non contractual document