

SUMMARY



Total pages: 58

Index 0	INTRODUCTION	→	page 2
Chapter 1			
Index 0	SPECIFICATIONS & WARRANTY	→	page 3
Chapter 2			
Index 0	SAFETY	→	page 7
Chapter 3			
Index 0	HULL	→	page 13
Chapter 4			
Index 0	DECK	→	page 17
Chapter 5			
Index 0	RIG & SAILS	→	page 23
Chapter 6			
Index 0	ACCOMODATIONS	→	page 32
Chapter 7			
Index 0	PLUMBING	→	page 38
Chapter 8			
Index 0	WIRING (drawings at the end of chapter)	→	page 42
Chapter 9			
Index 0	ENGINE	→	page 46
Chapter 10			
Index 0	LAUCHING	→	page 52
Chapter 11			
Index 0	LAYING UP & WINTER PRECAUTIONS	→	page 55
	PERSONAL NOTES	→	page 58
	ANNEX & OPTIONAL EXTRAS	→	End of manual



We share a common yearning for the sea. We, at Jeanneau as shipbuilders and you, who want to live your infatuation on the Seven Seas.

We are delighted to welcome you among the large family of Jeanneau boats owners, with our warm congratulations.

This manual is meant to help you enjoy and sail your boat comfortably and safely. It includes hints about the boat, the equipment and systems delivered or installed and operation and maintenance guidance. Before you take off to sea, read it carefully if you really want to make fun and avoid damages and troubles. Read carefully and make yourself at home on the boat, before you sail it.

We keep improving our boats as we want you to benefit from technological breakthroughs, new equipment or materials and our own experience; therefore, the characteristics and information provided are not binding and can be varied without notice or updating obligation.

This manual is designed in accordance with the ISO 10240 Standard requirements. This is a broad-line manual which may describe equipment or accessories, or address subjects which do not concern your boat; in case of doubt, you should check with the inventory submitted on the delivery of your boat .

Our network of Jeanneau distributors will be pleased to help you get acquainted with your boat and to take care of its maintenance.

If this is your first boat or if you are changing to a boat type which is new to you, before "taking command", get some training into the boat control and sailing, to ensure your safety and comfort. Your dealer or international sailing association, or yacht club will be pleased to suggest local sailing schools or professional instructors.

Keep this manual in a safe place and hand it over to the new owner if you sell your boat.

SPECIFICATIONS & WARRANTY



YOUR BOAT

GENERAL TERMS OF WARRANTY

LENGTH OVERALL43'4" / 13,21 m
 HULL LENGTH42'1" / 12,84
 LENGTH ON WATERLINE37'6" / 11,43 m
 OVERALL BEAM13'9" / 4,19 m
 WIDTH ON WATERLINE10'9" / 3,30 m

LIGHT DISPLACEMENT (standard)20350 lbs/9231 kg
 LIGHT DISPLACEMENT (shallow fin)20800 lbs/9435 kg

BALLAST WEIGHT STANDARD6619 lbs/2955 kg
 BALLAST WEIGHT SHALLOW FIN7078 lbs/3160 kg

DRAFT STANDARD6' 7" / 2,00 m
 DRAFT SHALLOW FIN5' 3" / 1,60 m
 CLEARANCE HEIGHT57'2" / 17,43 m

DISPLACEMENT IN MAXI. LOAD WEIGHT STANDARD ...26984 lbs/12240 kg
 DISPLACEMENT IN MAXI. LOAD SHALLOW FIN27434 lbs/12444 kg

MAXIMUM LOAD RECOMMENDED BY THE BUILDER6634 lbs/3009 kg

WATER TANK CAPACITY106 US gal/400 l
 FUEL TANK CAPACITY50 US gal/200 L
 ENGINE POWER RATINGS74 Hp (55 Kw) / 75 cv (55 Kw)
 BATTERIES CAPACITY2 x 110 Ah (12 V)

CABINS2/3/4
 BERTHS6 / 8 / 10

CE CLASSIFICATION 2 CABINS 3 & 4 CABINS

A 6 peoples 8 peoples

B 10 peoples 10 peoples

C 14 peoples 14 peoples

DESIGNER Daniel ANDRIEU
 BE JEANNEAU

CLASSIC MAST

MAINSAIL366 Sq.ft. / 34 m²
 GENOA581 Sq.ft./54 m²
 SYMMETRICAL SPI.....1291 Sq.ft./120 m²
 ASYMMETRICAL SPI...1109 Sq.ft./103 m²
 I50'9" / 15,485 m
 J15'3" / 4,660 m
 P44'6" / 13,560 m
 E17' / 5,200 m
 MAST LENGTH50'9" / 15,49 m

CLASSIC MAST

MAINSAIL409 Sq.ft./38 m²
 GENOA581 Sq.ft./54 m²
 SYMMETRICAL SPI.....1291 Sq.ft./120 m²
 ASYMMETRICAL SPI...1109 Sq.ft./103 m²
 I50'9" / 15,485 m
 J15'3" / 4,660 m
 P44'6" / 13,560 m
 E17' / 5,200 m
 MAST LENGTH50'9" / 15,49 m

Class A: «In the Open Sea»

Boat designed for long trips, during which the wind may exceed 8 on the Beaufort Scale and the waves may exceed a 4 m significant height

To a large extent these boats are self-sufficient for these kinds of trips.

Sun Odyssey 43 DS conformity to CE directive 94/25 is attested by Bureau Veritas

(CE certificate n° 6632.0415.AO.9CE-RDC @01/12/2000).

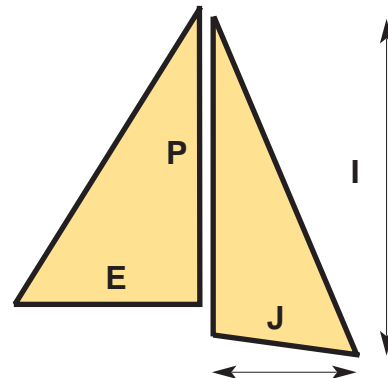



YOUR BOAT

Version :

NAME OF BOAT :

OWNER'S NAME :

ADDRESS :

HULL NUMBER :

SERIAL NUMBER :

REGISTRATION NUMBER :

DATE OF DELIVERY :

ENTANCE KEYS NUMBER :

MAKE OF ENGINE :

ENGINE SERIAL NUMBER :

ENGINE KEYS NUMBER :

Your dealer



CHANTIERS JEANNEAU - BP 529 - 85505 LES HERBIERS cedex - FRANCE
 Tel. (33) 02 51 64 20 20 - Fax : (33) 02 51 67 37 65
 3615 JEANNEAU (2,23F / mn) - Internet : [http://www.jeanneau.com\(fr\)](http://www.jeanneau.com(fr)).



specifications



GENERAL TERMS OF WARRANTY

Article 1

At the moment of delivery of the boat, the parties sign the Certificate of Delivery supplied by CHANTIER JEANNEAU for this purpose ; it is equivalent to an agreement of compliance by the Purchaser / user.

The acceptance of delivery by the Purchaser / user, without any reservation, is equivalent to the acceptance of the apparent condition of the boat, in pursuance to the provisions of articles 1642 of the Civil Code. The terms of Warranty are engaged solely upon :

- the return to CHANTIER JEANNEAU After-Sales Department of the completed tear-away section of the Certificate of Delivery and of Warranty Registration Card,

- the following of the directives on verifications set forth by CHANTIER JEANNEAU ;

It is made clear that the possible expenses of handling, transportation, parking, escort, etc. non-inclusively which have been incurred in the execution of the above-mentioned directives and verifications are born exclusively by the Purchaser-User.

Article 2

The Warranty is valid for a duration of 12 months from the date of delivery of the Boat to the first Purchaser-User ; it is strictly limited, as the Manufacturer chooses, to the replacement or free repair of any part that has been deemed to be defective by the technical specialists of the latter. No compensation whatsoever shall be paid in connection thereto.

As for components and accessories which bear the trademark of another Supplier, the Warranty shall be limited to the Warranty provided by said Supplier.

Article 3

With the exception of any prototype and RIGIFLEX boats, and boats used for commercial purposes, or boats specifically designed and / or equipped for racing, which have as a contractual Warranty only that which is indicated in Article 2 above, the structure of the hull, the deck, and the hull-to-deck joint, and the keel-to-hull joint is warranted against all defects in material and workmanship identified by the technical specialist at CHANTIER JEANNEAU for a period of 5 (five) years for monohull sailboats, and period of 3 (three) years for motorboats and multihull sailboats.

However, any incident (affecting the structure and not resulting from a manufacturing defect covered under the Conditions of Warranty), whether or not resulting in the repair of the deck or hull, shall effectively cancel immediately without prejudice all terms and Conditions of Warranty.

The Warranty Period shall start from the date of the first commissioning into service of the Boat, and at the latest from the last day of the model year in which the Boat was built, i.e. the 31st of August of sail year.

This Warranty is strictly limited to the free repair of the manufacturing defects either in our yard or by a repair shop or shipyard chosen by our company. No compensation whatsoever shall be paid in this respect.

Article 4

The following items are excluded from the Terms of Warranty as stated in Articles 1 and 2 above :

- all carriage and transportation-related expenses including parts as well expenses and / or possible losses resulting from the inability to use the Boat and / or accessories, shall be born by the Purchaser / User.

- the wear and damages hereinafter listed as well as their consequences :

- Normal wear and tear,
- Cracks, craking, or fading of the gel coat,



- Damages resulting from :
 - changes, modifications, alterations, or repairs (even partial ones) performed by shipyards other than those authorized by the Manufacturer,
 - failure to follow the recommended maintenance procedures stated precisely in the owner's manual that was delivered with the boat, or failure to follow recognized procedure,
 - improper use, in particular negligent use, or rash use, misuse, or abnormal use,
 - participation in competitive events,
 - negligent acts in which the necessity of taking conservative measures of action is disregarded,
 - accident or catastrophe such as but not limited to explosion, fire, flood, storm, lightning, transport, riot, theft, and collision,
 - unsuitable storage or transport conditions.

Article 5

The application of the warranty shall extend the period of the Conditions of Warranty only for a period equal to that which is necessary to carry out only the repair work required under the Warranty, on the condition that the aforementioned repair work requires immobilization of the boat for a minimum of 7 (seven) consecutive days.

Article 6

In order to exercise the Conditions of Warranty previously defined, the Purchaser/User shall submit the complete Certificate of Delivery and present the Conditions of Warranty document each time a claim is presented, and shall notify the authorized Dealer/Seller of the defect or fault within 15 days from the day that the defect or fault is discovered. This notification shall be written, precise, and justifiable. Failure to notify the authorized Dealer/Seller will result in the forfeiture of the Conditions of Warranty.

Upon receipt of said notification from the Purchaser/User, the authorized Dealer/Seller shall inform the Manufacturer about the Purchaser/User's claim within a period of 8 (eight) days ; failure to notify the Manufacturer shall result in the Dealer/Seller's liability as a result of the delay.

Article 7

Authorized Dealers, Agents, or Sellers of CHANTIERS JEANNEAU do not have the authority to alter the above Warranty, but may, on their own account, and of their own responsibility, grant possible additional warranties which can, under no circumstances, be held to Manufacturer.

PRECAUTION BEFORE ANY REPAIR :

Contact your Jeanneau agent for best advice about products and materials when you want to execute some repairs for yourself.
Important repairing of the hull and engine must be done by a professional.
Your Jeanneau's agent can do it or appoint you a professional.

DANGER

Contact your Jeanneau agent to know what is possible to repair and particularly what you must not do !
You could endanger your safety and lose your warranty.



SAFETY



SAFETY EQUIPMENT

SAFETY DIRECTIONS CONCERNING THE GAS STOVE

FIGHT AGAINST FIRE

BILGE STRIPPING

EMERGENCY TILLER

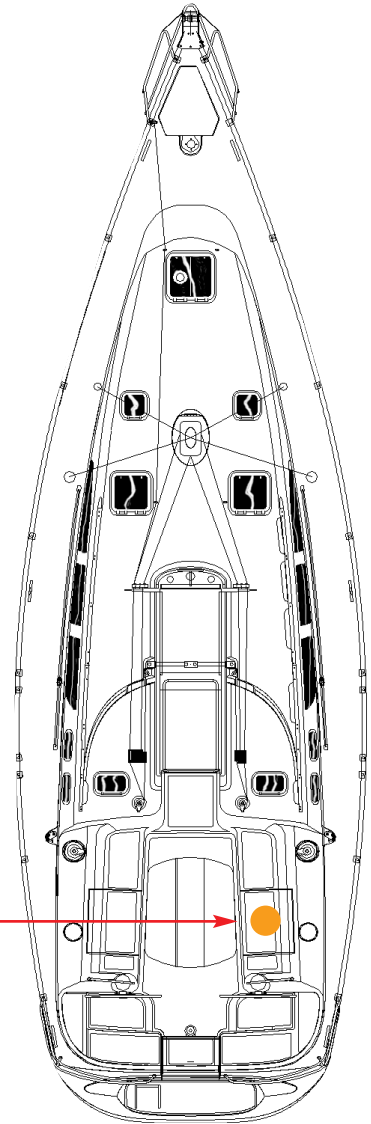



SAFETY EQUIPMENT

The life raft is located in the cockpit locker.

RECOMMENDATION / LIFE RAFT

The locker shall never be padlocked at sea.
The launching procedure is indicated on the raft and should be read carefully before taking to sea.

WARNING

Check the safety equipments inventory before each trip.

safety



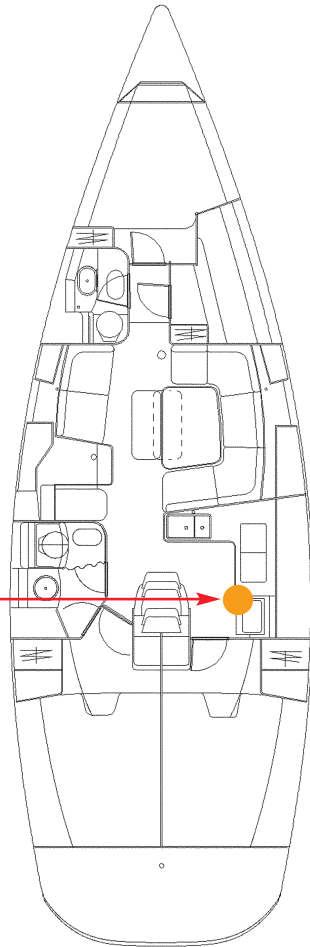

Same place for other accomodation versions

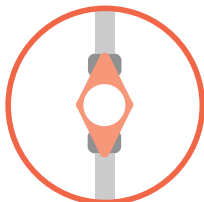

Valve open

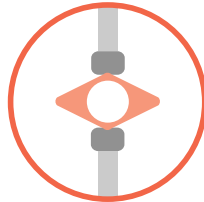

Valve closed



SAFETY DIRECTIONS CONCERNING THE GAS STOVE

Type : "Camping-Gaz" (butane, duty pressure : 142 lbs per sq. inch / 10 kg/cm²)

- Shut the valves in the system (under the oven) and on the cylinder when the appliances are not in use. Shut immediately all valves in case of hazard,
- Never leave appliances burning unattended,
- Ensure that the appliances valves are shut before opening the cylinder,
- Regularly test the gas system for leaks.

Shut the appliance valves and open the cylinder and check all connections for leaks with soapy water or a detergent solution. In case of leak, shut the cylinder valve and repair before using the cylinder again.

The appliances burn the oxygene in the cabin and release combustion gases, therefore a ventilation is mandatory when the appliances are used.

- Don't use the oven or cooker for make up eating,
- Leave the ventilation openings unobstructed (grid in companionway) hatch,
- Immediate access to the gas system components must be unobstructed at all times,
- Empty cylinders must be disconnected and their valves must be shut,
- Keep the protective covers, plugs and hatches in place,
- Store the empty or spare bottles on the deck or in a locker, if ventilated towards the outside,
- Regularly check and replace the rubber tubes five years after the indicated date of manufacture,
- Never use the gas cylinder compartment for storage of equipment.

WARNING

Never use an ammonia solution.
Never use a flame to test for leaks.
Do not smoke or use an open flame while replacing the gas bottle.

safety



SUGGESTIONS TO SET THE EXTINGUISHERS

(It is possible to set them in other places but the extinguishers shall be at least 5 meters from each berth)

An extinguisher shall be **in any case** at least 2 meters from the extinguisher aperture.

An extinguisher or a fire blanket (ISO 1869) shall be at least 2 meters from each open flame appliance.

An extinguisher shall be at least 1 meter from the helmsman.

REMIND:

The extinguishers are part of required equipment.

Extinguisher, minimum capacity 5A/34B
Need for the SUN ODYSSEY 43 :

- 2 cabins version : 10A/68 B (2 Extinguishers mini.)
- 3 cabins version : 15A/102 B (3 Extinguishers mini.)
- 4 cabins version : 20A/136 B (4 Extinguishers mini.)

- 1 - Under chart table
- 2 - Against kitchen furniture
- 3 - Extinguisher aperture
- 4 - Against hanging locker in cabin
- 5 - In stowage locker



Emergency exit in case of fire

A - Fore cabin hatch

B - Saloon hatch

C - Companionway

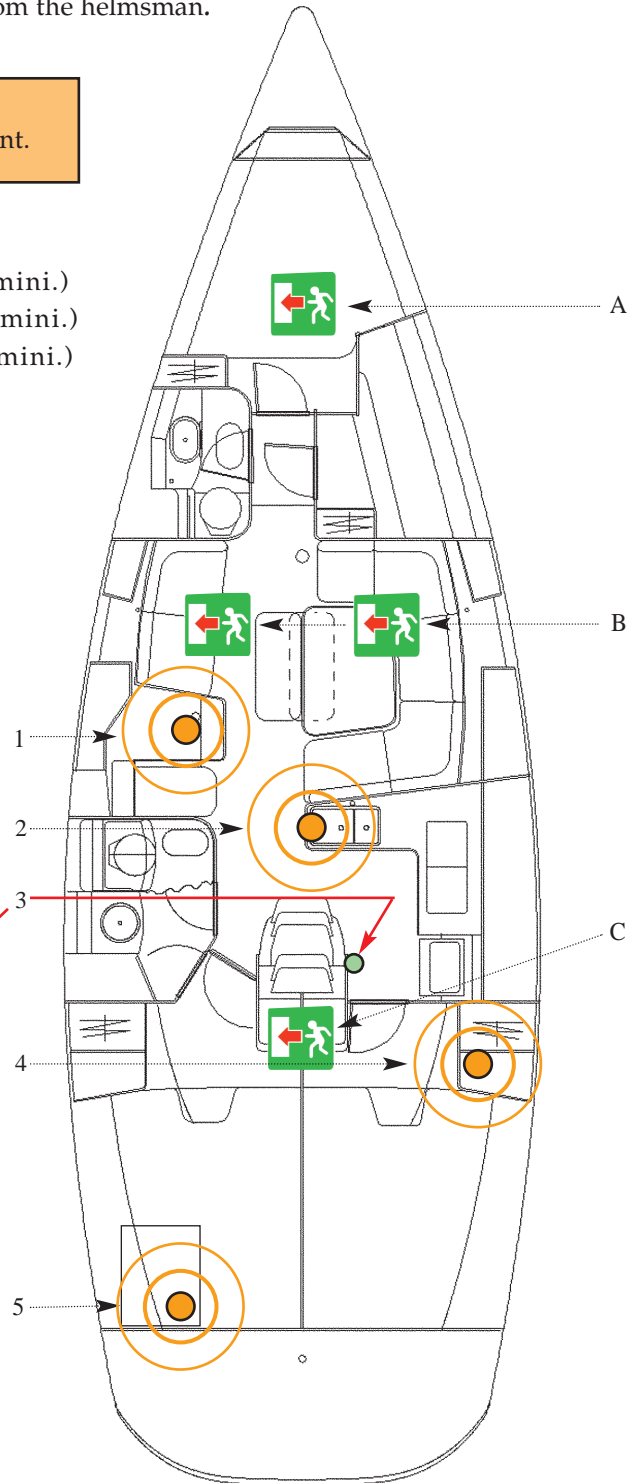
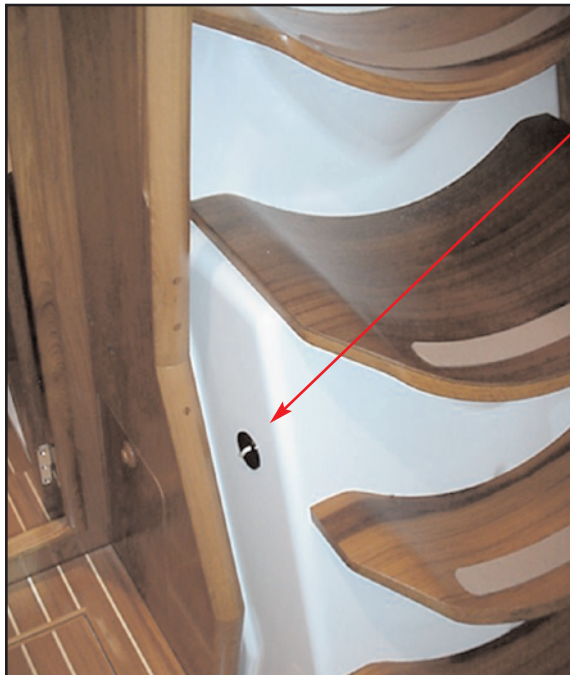

Same place for other
accommodation versions



FIGHT AGAINST FIRE

The extinguisher must be located within easy reach and away from possible fire.

The engine compartment includes an aperture to inject the extinguishing agent without opening the normal access hatch.

Steps to be taken in case of fire in the engine compartment :

- Stop the engine,
- Switch off power and shut the fuel supply,
- Inject the extinguishing agent through the aperture,
- Wait a minute,
- Open the access hatch for access to repairs.

PRECAUTION

Keep an extinguisher nearby to react in case the fire should resume.

It is the owner's or the skipper's responsibility :

- . To have the extinguishers checked in accordance with the instructions given.
- . When the extinguishers expire or are empty, to replace them by extinguishers with an equal or greater capacity.
- . To tell the crew where the extinguishers are, how they work, and where the emergency exits are.
- . To make sure that the extinguishers can be reached easily when there are people onboard.



WARNING

Never :

- . Obstruct the ways to the emergency exits.
- . Obstruct the safety controls (fuel oil valves, gas valves, switches).
- . Block the extinguishers located in the lockers.
- . Leave the boat vacant while a stove or a heater is on.
- . Use gas lamps in the boat.
- . Change the boat systems (electricity, gas, fuel).
- . Fill a tank or change a gas bottle when the engine is running or when a stove or a heater is on.
- . Smoke while handling fuels or gas.

safety



Keep the bilge clean and regularly check if there is fuel or gas vapor.
For the extinguishers you shall use only compatible spare parts ; they shall have the same information or they shall be equivalent as far as their technical qualities and their heat resistance are concerned.

See to it that the curtains are not hanging loose close to the stoves or other appliances with an open flame.

The combustible products shall not stored in the engine compartment. If you store non-combustible products in the engine compartment, they shall be fastened so that they cannot fall onto the engine or block the way.

WARNING

The CO₂ extinguishers shall be used to fight against **electric fires** only.
In order to avoid suffocation, clear the area immediately after use and air before entering.







BILGE STRIPPING

ELECTRICAL BILGE PUMP

The electrical bilge pump can be energized from the electrical switch board.

EMERGENCY BILGE PUMP

The manual bilge pump is located in the cockpit.
The control arm must be accessible permanently.

EMERGENCY TILLER

The emergency tiller is stored inside an aft chest and should be accessible at all time.

To operate the tiller, proceed as follows :

- Unscrew with a winch handle the emergency tiller cover, located on the aft cockpit seat.
- Engage the tiller in the rudder stock ensuring that it is fully home in the square.

(Refer chapter 4, steering gear)

HULL

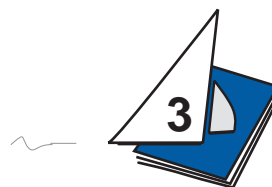

CONSTRUCTION

HULL MAINTENANCE

DRY DOCKING

GEL-COAT REPAIR INSTRUCTION



CONSTRUCTION

Your boat is built of GRP.

Stresses are distributed over the whole bottom surface by means of floors integral with the hull. Pig iron ballast is secured to the hull by means of bolts and back-plates laminated in place.

The deck is made of balsa-wood sandwich with hard wood inserts in way of equipments. The deck-hull link is ensured by polyester sealant bonding and reinforced by the aluminium toe rail bolting.

HULL MAINTENANCE

The equipment and materials of your boat were selected because of their performance and quality, and ease of maintenance; nonetheless, a minimum maintenance will be required to protect your boat from outside attacks (sun, salt, electrolysis...).

Use the less cleaner products if possible and do not reject them in the sea.

Try to wash your boat on shore.

Do not use any solvent or solvent based products. (See next page)

The hull shall be washed frequently with ordinary cleaners and fresh water.

PRECAUTION

We strongly advise your to refrain from using hydrojet cleaning.
Hot water or steam are prohibited.

hull

PTE

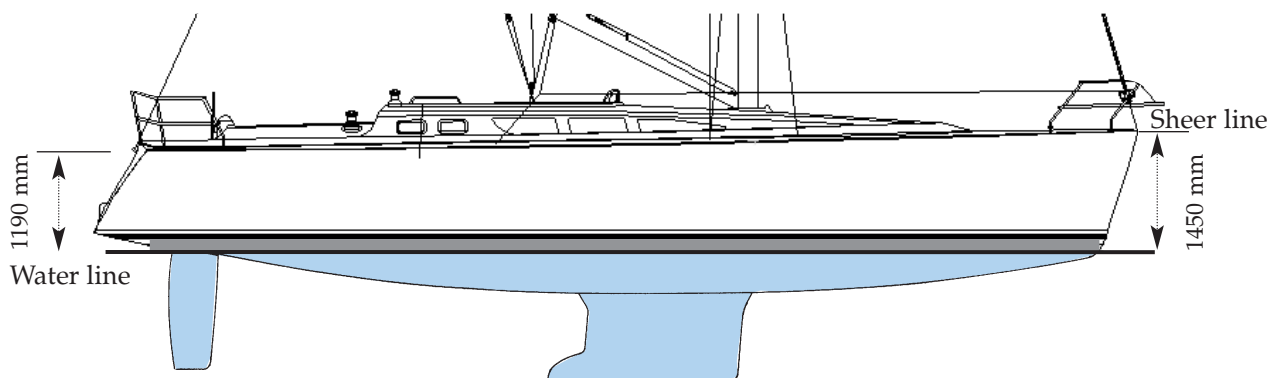

Wetted area : 37,60 m² - (this measurements are for " light boat ")

GTE

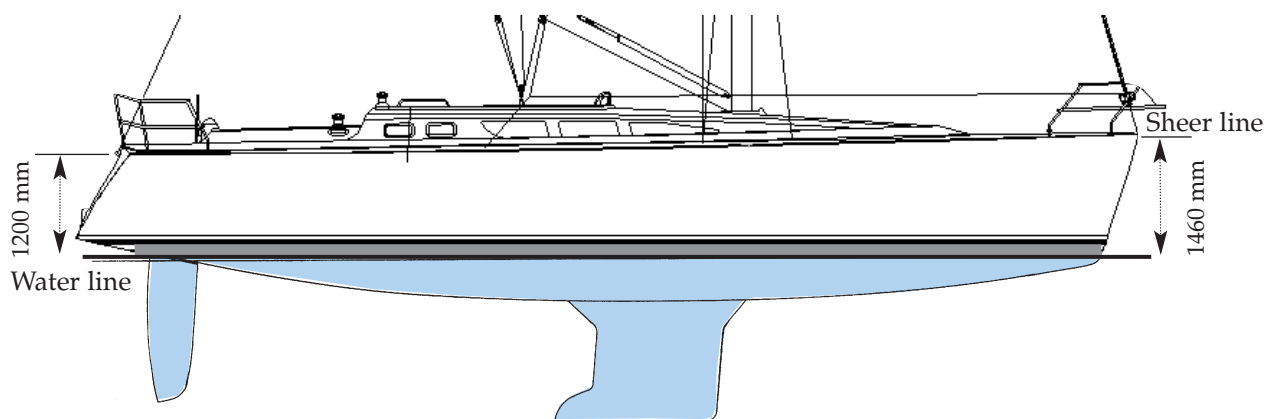

Wetted area : 38 m² - (this measurements are for " light boat ")



DRY DOCKING

(Refer to section 10 for launching instruction)

An annual application of tinless anti-fouling will spare time-consuming and frequent dry-docking. An epoxy coat is nonetheless recommended. In that respect, we must remind you that sanding or priming before anti-fouling are tantamount to attacking your gel-coat and impair its reliability. Therefore, we recommend very gentle sanding.

Hydrochloric acid may be used against rooted fouling in way of the boottop, allowed to act for 10 minutes and rinsed liberally.

Polish pastes can restore the gloss of your ship. In case of lasting problems, consult your distributor.

Biodegradable cleaners and maintenance products have been tested and approved by the shipbuilder, since they protect both the materials and environment.



GEL-COAT REPAIR INSTRUCTION

hull

MIXING RATIO :

Our products include an accelerator, you just have to add the catalyst (colourless liquid).
The usual ratio is 2%.

The gel setting-time is about half an hour, curing takes approximately ten hours.

PRECAUTION

Successful repairs require two critical factors:
a dry weather, a temperature between 15° et 25°C.

APPLICATION :

- To seal off scratches or blister holes, clean the surface with acetone and sand the area,
- Prepare the required amount of gel-coat preferably on a glass plate,
- Apply the product with a spatula or pointed tool,
- Apply an over-sized coat to allow for sanding with abrasive and water and polishing to achieve the required gloss,
- Blending minor touch up on smooth surfaces is obtained by sticking scotch tape (or better still, Mylar tape) on the freshly applied gel-coat, then separate it after curing (sand with extra-fine abrasive and polish to obtain a high gloss finish).

WARNING

The catalyst is a dangerous product and should not be left within children reach.
Avoid contact with the skins and mucosa.
In case of contact, wash with soapy water and rinse liberally.



GEL-COAT STORAGE :

Get-coat components must be stored in a cool place, protected from moisture and light for maximum 6 months, to ensure adequate preservation. The usual precautions for flammable products should be adhered to for polyester products.

TOOLS CLEANING :

Clean all tools with acetone.

DECK



SAILING

MOORING

TOWAGE

ANCHORING

DECK MAINTENANCE

STEERING GEAR

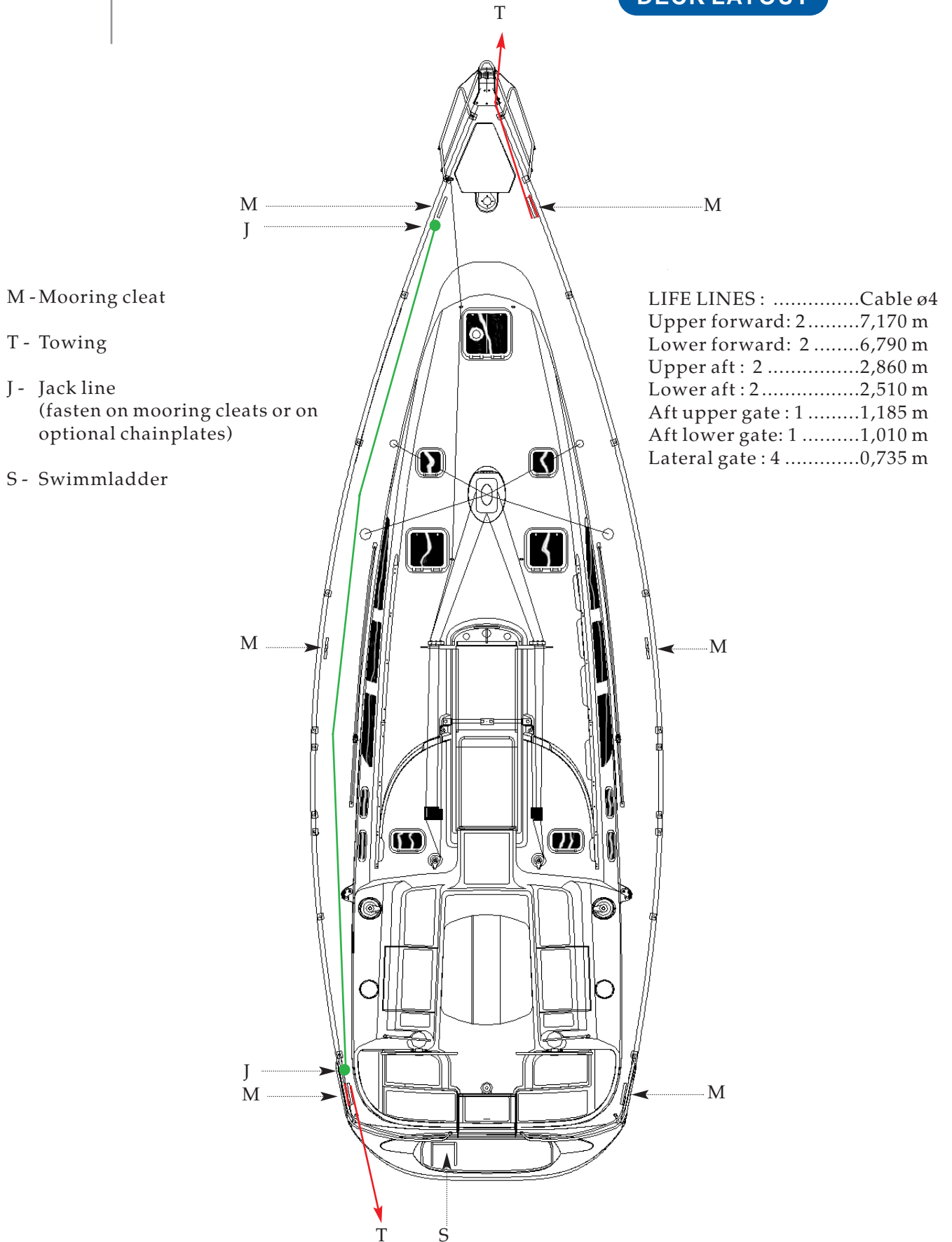



SAILING

DANGER

Wear your life-jacket ; In heavy weather, wear the safety harness and hang you on the boat.

deck



MOORING

A sufficient number of mooring ropes, of adequate dimensions and suitable for the environment should be on board.

- Always manoeuvre the boat with the engine,
- Handle the boat consistent with the current and wind,
- Protect the boat with suitably-sized fenders,
- Always keep the ropes unfouled and home,
- Handle the boat at slow speed.

DANGER

Never try to stop the boat with your foot, your hand or a boat-hook.



When taut :

- Protect the ropes from chafing with plastic sleeves,
- Make allowance for the tide, as the case may be.

TOWAGE

Tug:

Tow slowly and avoid tightening and slackening.

Be especially watchful when sending or catching the tow-line: Propellor may be fouled by a rope during these handlings.

Towed boat:

Keep steering and be carefull not to stray from tug's wake.



ANCHORING

As a general rule, the chain should be paid out over at least three times the depth of water.

PRECAUTION

Before anchoring, check the depth of water, current power and nature of the sea bed.

ANCHORING :

PRECAUTION

If your boat is fitted with an electrical windlass, keep the engine running during all anchoring operations to avoid discharging the batteries. In case of battery failure, perform the manoeuvre manually.

- Luff the boat through without way on her,
- Pay out and keep the chain under control with the windlass brake.

When anchored :

- Release the chain or cable from the cable-lifter,
- Secure the chain on the windlass cleat.

PRECAUTION

Don't use the cable lifter to secure the chain.

**HEAVING UP ANCHOR :**

- Lock the windlass snubber,
- Ensure that the chain is properly seated in the cable lifter,
- Heave in slowly with the engine. Don't use the windlass to hoist the boat,
- Heave the anchor up to the pipe,
- Check the anchor for position on the bow bracket for changing berth, or secure it into the chain locker,
- With an electrical windlass, switch the power off immediately when the chain is fast.

PRECAUTION

Adjust the chain under the windlass sheave and **keep your hand away !**

STERN ANCHORING :

- Stern anchoring should be performed with the engine declutched,
- Secure the required length of the cable on the mooring cleat,
- Pay out slowly to avoid damaging the propeller or rudder blade.

WARNING

All windlass operations are dangerous ; therefore,
the anchor line shall always be clear and free ;
Always proceed with care and using gloves.

**RECOMMENDATIONS/MAINTENANCE**

After every trip, rinse the windlass and anchor chain with fresh water.
Refer to the manufacture's brochure for windlass maintenance
before and after the season.



DECK MAINTENANCE

Use the less cleaner products if possible and do not reject them in the sea.
Try to wash your boat on shore.

Do not use any solvent or solvent based products. (Refer Section 3)

Regularly brush the deck with a degreasing shampoo and fresh water.

EQUIPMENT :

- Rinse liberally all equipment with fresh water,
- Regularly lubricate all blocks, sheaves, bottle screws, winches, rails and travellers with a water-repellent grease,
- Brighten up stainless-steel components with "Mirror" polish as soon as oxidation spots appear on the surface.

OUTSIDE TEAK WOOD :

- Regularly rinse woodworks with fresh water,
- Dress teak-wood with fine sand paper to restore its colour.

PLEXIGLASS :

- Rinse plexiglass with fresh water (do not use any solvent base products),
- Brighten up with soft rags soaked in paraffin oil,
- Use special polish paste adhering to remove scratches.

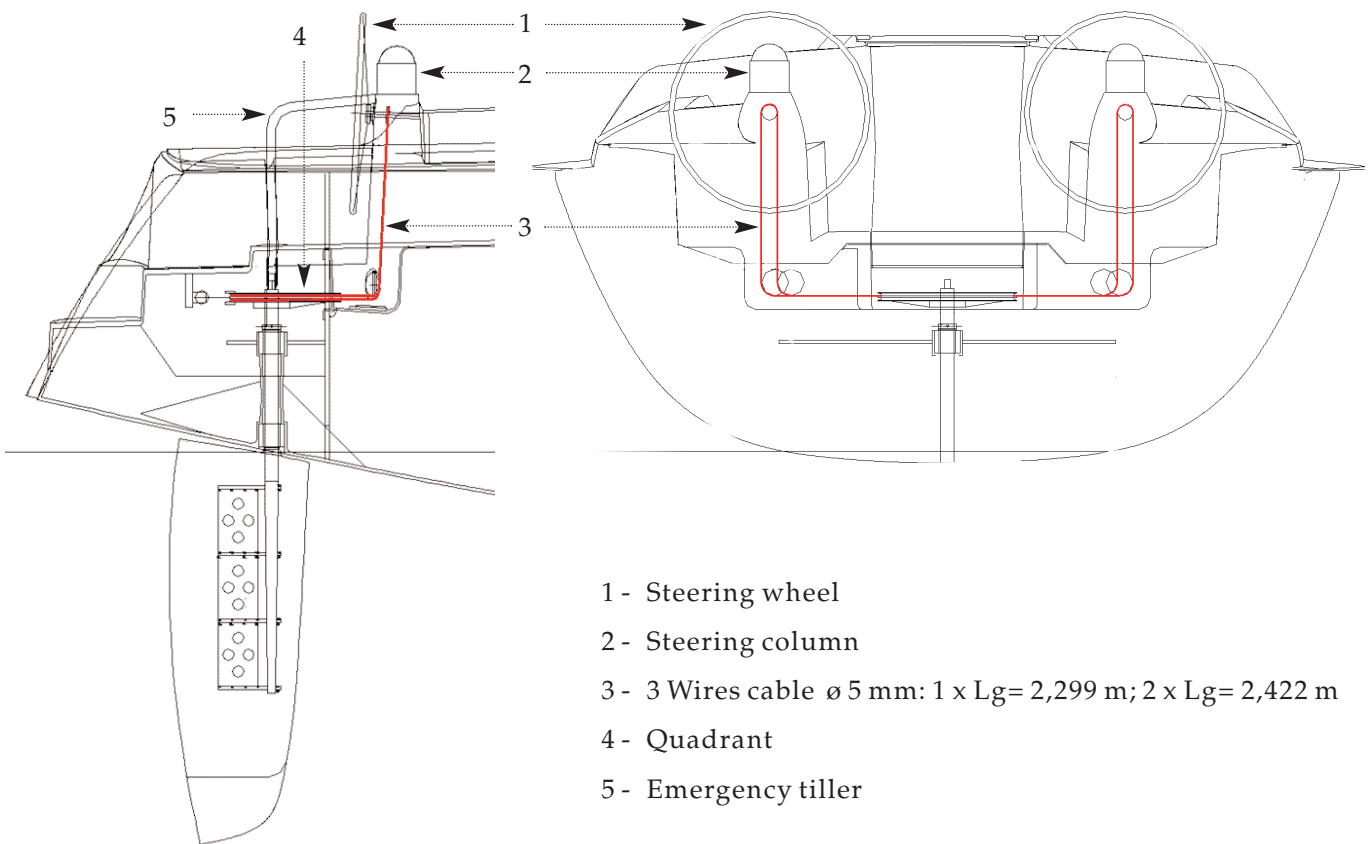

Access to wires via the port aft cockpit locker



STEERING GEAR

Check regularly all tightenings.

Lubricate all components.

Use exclusively WD40 compound on nylon, ertalon or the teflon bushes.

Adhere to the manufacturer's instructions for the tiller system.

deck

RIG AND SAILS



STANDING RIGGING

RUNNING RIGGING

WINCHES

FURLERS

SAILS

STANDING RIGGING

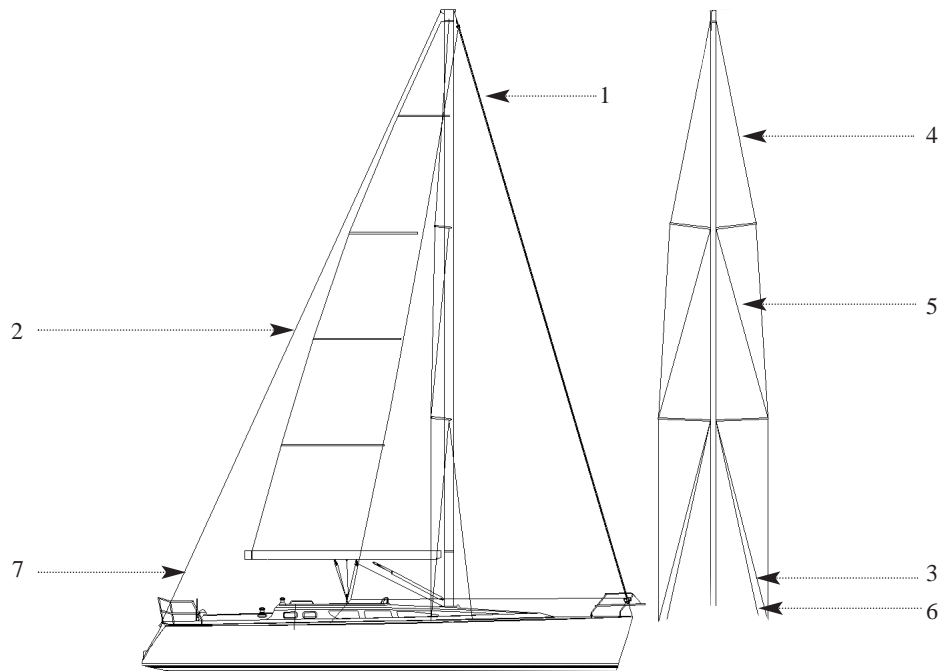

Qté	Réf.	Désignation	Terminaisons	
1		ETAI CA Ø10	ECA/EO+CD	Forestay
		Longueur hors tout : 16270 Longueur de contrôle : 16210		
2		PATARAS CA Ø08	EB+CFL . EO+LTT	Backstay
		Longueur hors tout : 13455 Longueur de contrôle : 13430		
3		BASHAUBAN AR CA Ø 8	EB+COQ/ROCS	Aft lower shroud
		Longueur hors tout : 5740 Longueur de contrôle : 5520		
4		GALHAUBAN CA Ø 10	EB+COQ/ROCS	Uppershroud
		Longueur hors tout : 15610 Longueur de contrôle : 15330		
5		INTER CA Ø 8	EB+COQ/ROCS	Inter.
		Longueur hors tout : 10945 Longueur de contrôle : 10735		
6		BASHAUBAN AV CA Ø 8	EB+COQ/ROCS	Fore lower shroud
		Longueur hors tout : 5555 Longueur de contrôle : 5340		
7		PATTE D OIE CA Ø 7	EO/ROCS	Bridle
		Longueur hors tout : 4000 Longueur de contrôle : 3790		



STANDING RIGGING

Proceed as follows to install or remove the mast on your own :

BEFORE MAST INSTALLATION :

- Protect the mast from chafing with the hook and hoist cable,
- Secure the shrouds and ropes to the mast base with a hitch of sufficient length to guide the mast foot during handling,
- Protect the spreaders end pieces,
- Install a 1.50 m rope around the mast with a thimble on each end and wrapped with rags. Install the rope below the second tier of spreaders. Connect both thimbles by means of a sufficiently strong shackle to receive the crane hook, ahead of the mast. Raise the assembly until it is taut under the spreaders basis.

DANGER

Before mast installation, be sure to have enough room to move.
Contact or closeness of electric wires may incur electrocution.



DURING MAST INSTALLATION :

- Take all steps necessary to avoid damaging the equipment on mast head,
- Control the handling by means of the backstay and mast base hitch,
- Ensure that the mast base rests fully on its support plate.

AFTER MAST INSTALLATION :

- Check the spreaders for security and position: they must always be above the horizontal,
- Lubricate all bottlescrews (refer to "Hints", chapter 5),
- Make the shrouds fast (refer to chapter 5 for "Settings"),
- Insert the wires in the cable glands, re-feed the cable glands and connect up the electrical cables (refer to chapter 8 "Electricity"),
- Carefully check that the bottlescrews securing pins are locked and protected by adhesive tape,
- Re-install the boom and refit all ropes,
- Carefully check that the mast collar sleeve is waterproof ; Seal the mast groove with silicone.

Adjust the mast again after a few trips out to sea.

MAST DISMANTLING :

Proceed in reverse order taking care to mark the rope locations with stickers.

- 1- Navigation and mooring light
- 2- Backstay attachment
- 3- Schroud attachment
- 4- Spinnaker chainplate and forestay attachment
- 5- Babystay attachment (Option)
- 6- Spinnaker pole lift sheave
- 7- Lazy-jacks eyes
- 8- Spreader attachment
- 9- Intermediate attachment
- 10- Steaming/deck light
- 11- Spreader attachment
- 12- Aft lower shroud attachment
- 13- Fore lower shroud attachment
- 14- Spinnaker halyard exit
- 15- Main lift exit
- 16- Genoa 1 halyard exit
- 17- Main halyard exit
- 18- Spinnaker pole lift exit
- 19- Genoa 2 halyard exit
- 20- Reefs eyes
- 21- Automatic reef bullseye
- 22- Spi pole car sheave
- 23- Spi pole track
- 24- Spi pole car
- 25- Halyard ring
- 26- Vang fitting
- 27- Boom topping lift jammer
- 28- Gooseneck
- 29- Main sheet eyes
- 30- Reefs eyes
- 31- Boom fitting

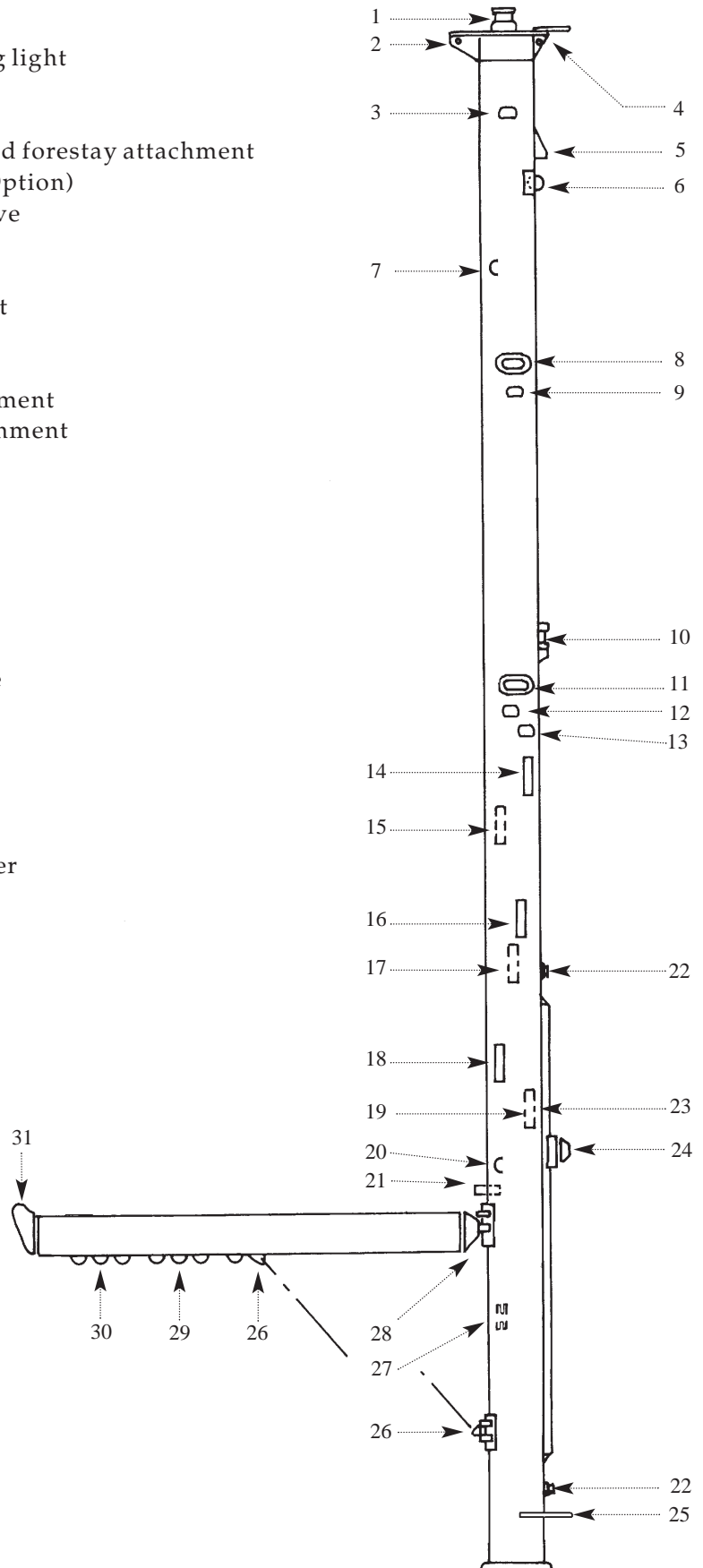



TRIMMING :

An agent has proceed to the first adjustments and cable tension. After few trips you will have to do the final adjustment to obtain a correct rectitude in transversal; it is also important to keep the mast rectilinear in longitudinal when sailing.

Therefore, it needs compensation adjustment along side; a first bending of the mast in longitudinal is required : the middle of the mast bended forward and the head afterward. The bend must be the half of the mast section.

COMPENSATION ADJUSTMENT

- 1 - This is a pushing spreader rigging, so you will have to stretch the upper shrouds before the backstay.
- 2 - Stretch tightly all the rigging (the rigging must be a little bit loosely when sailing with 15-20 knots).
- 3 - When a perfect transversal and longitudinal rectitude has been obtained, ease t h e both side aft lower shrouds with 2 turns of bottlescrew.
- 4 - Finish longitudinal adjustment by stretching tightlier the backstay bottlescrew to obtain a good stability of the forestay when sailing by 15-20 knots.

Fasten with pins all the bottlescrews and keep this trimming during all the sailing season.

Ease the backstay during the wintering.

FURLING MAST

- 1- Navigation and mooring light
- 2- Backstay attachment
- 3- St. st. main swivel
- 4- Schroud attachment
- 5- Spinnaker chainplate and forestay attachment
- 6- Babystay attachment (Option)
- 7- Spinnaker pole lift sheave
- 8- Spreader attachment
- 9- Intermediate attachment
- 10- Steaming/deck light
- 11- Spreader attachment
- 12- Aft lower shroud attachment
- 13- Fore lower shroud attachment
- 14- Spinnaker halyard exit
- 15- Genoa 1 halyard exit
- 16- Genoa 2 halyard exit
- 17- Main halyard exit
- 18- Spinnaker pole lift exit
- 19- Main lift exit
- 20- Spi pole car sheave
- 21- Spi pole track
- 22- Spi pole car
- 23- Halyard ring
- 24- Vang fitting
- 25- Main furler storage
- 26- Boom topping lift jammer
- 27- Gooseneck
- 28- Main furler eye
- 29- Main sheet eye
- 30- Boom fitting
- 31- Main clew car

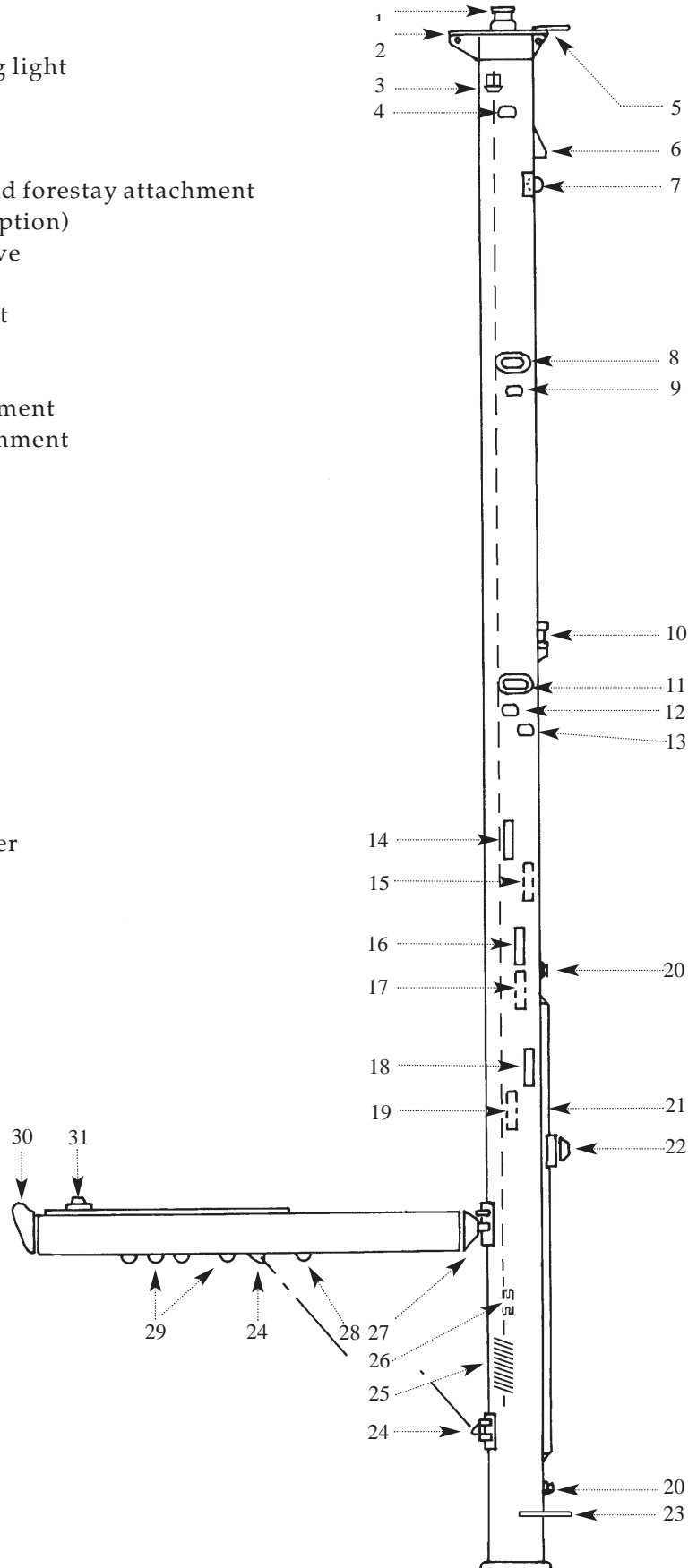



MAINTENANCE :

Thoroughly check the mast from top to bottom before each trip.

- Check regularly the rigging for tensioning and the lock-nuts or pins for safetying, The first inspection shall be performed after a few days at sea in various weathers,
- Secure, lubricate and check the bottlescrews for tensioning : if the rigging should be loose, the chain plate friction may generate wear,
- Never lubricate bottlescrews with silicon grease : use tallow, graphite grease or other,
- Change all shrouds or stays exhibiting kinks, severed wires or other defects,
- Regularly check the chain plates and stays for condition.

Your Jeanneau agent can take care of all the above maintenance operations.

DANGER

When hoisting a mate up to the mast, never use the halyard snap or shackle :
make up a bowline with the halyard direct on the bosun chair ring.
Do not hoist a mate when sailing in heavy weather.



RUNNING RIGGING MAINSAIL- STARBOARD

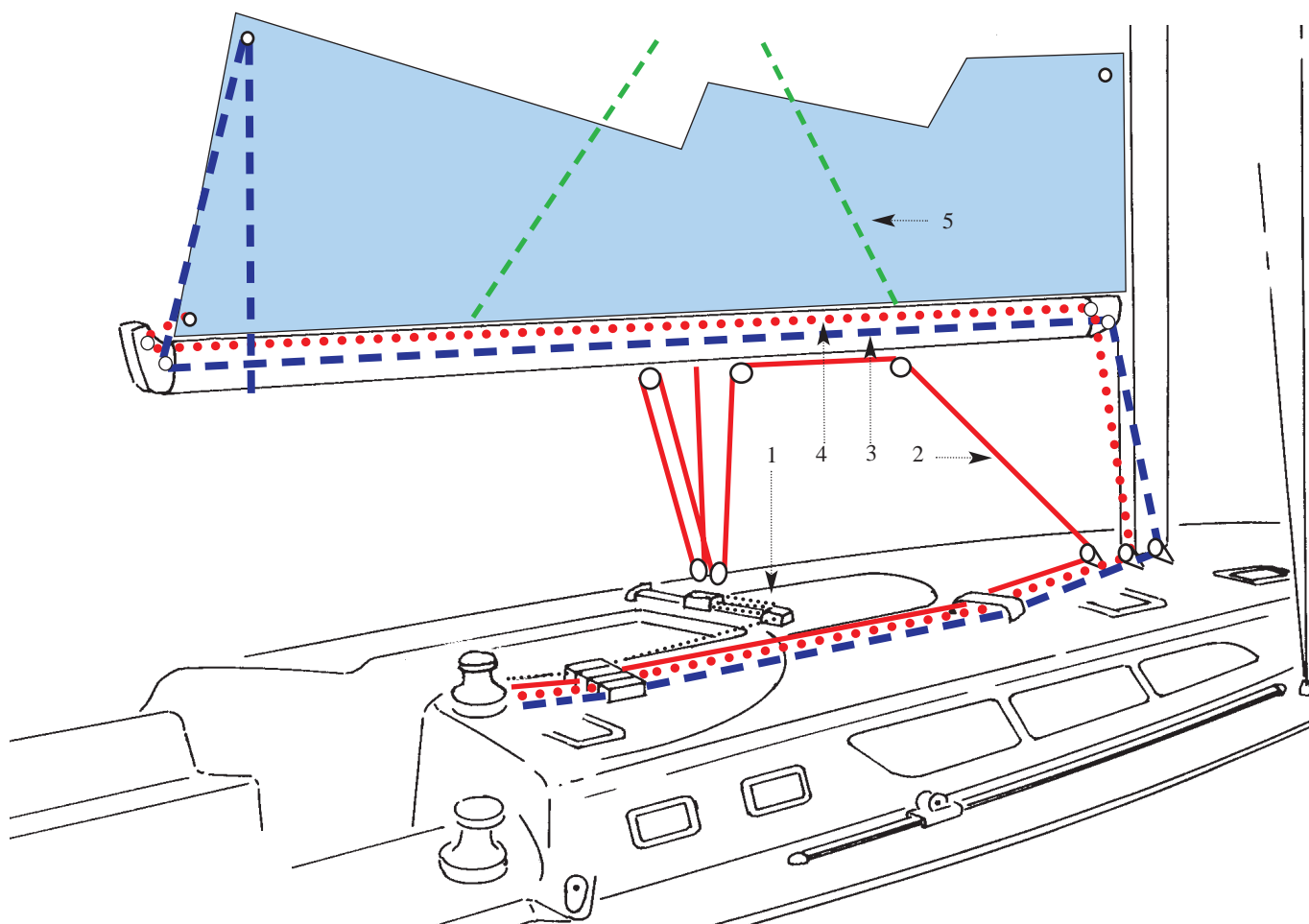

CLASSIC MAST VERSION

	Rope designation	Nb	Type	Color	Ø(mm)	Length (m)
1	Horse adjustment	2	Braid H	White	8	7
2	Main sheet	1	Braid H	Red	12	27
3	Main foot band	1	Braid H	White/Red	10	12,5
4	Reef 3	1	Braid H	White/Blue	10	30
5	Lazy-jacks	2	Braid H	White/Green		
Braid H : Braid halyard						



RUNNING RIGGING

MAINTENANCE :

Lubricate the sheaves with silicon : change distorted or dented sheaves. Inspect the shafts in sheaves on mast head.

Regularly check the jam cleat jaws for condition.

Inspect the halyards for wear and condition.

Clean the blocks regularly (worn out grease, corrosion spots) and slightly oil up the pins.
Avoids untimely gibing which generate premature wear on the sheets and fixed points.

RUNNING RIGGING MAINSAIL- BACKBOARD

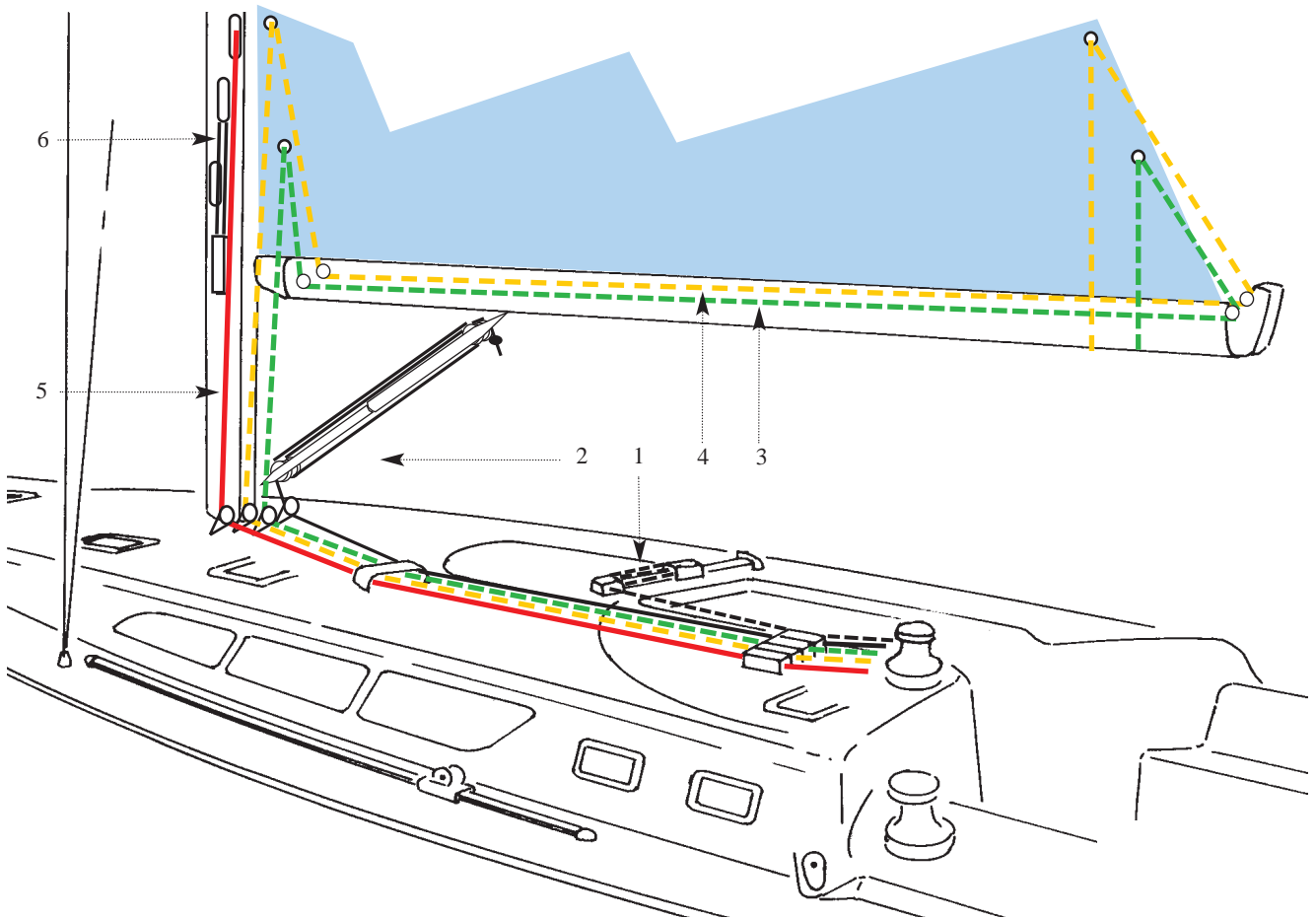

CLASSIC MAST VERSION

	Rope designation	Nb	Type	Color	Ø(mm)	Length(m)
1	Horse adjustment	2	Braid H	White	8	7
2	Vang	1	Braid H	Black	10	11
3	Reef 1 (auto)	1	Braid H	White/Green	12	25
4	Reef 2 (auto)	1	Braid H	White/Yellow	12	35
5	Main halyard	1	Braid H	Red	12	37
6	Main topping lift	1	Braid H	White	8	32
Braid H : Braid halyard						



WINCHES

Avoid rope entanglement during winch handling. Don't leave loose ropes on the winches, instead fasten the ropes around cleats. Adjust the winches on receipt of the boat and rinse the winches regularly. Winches shall rotate freely and need being overhauled as soon as seizing becomes obvious.

RECOMMENDATIONS / MAINTENANCE

The winch maintenance shall be performed in full regularly, before, and twice or three times during the sailing season :

Remove, clean and lubricate the drums with a film of white or Teflon grease to reduce friction and control corrosion. This type of grease which is clean, non-toxic and biodegradable should be used preferably.

WARNING

Refer to the manufacturer's instructions to remove and refit the winches : improper refitting may result in accidents, e.g. back kick of the crank handle.



SELF-TAILING WINCHES ADJUSTMENT :

Adjust the winch jaw to the relevant rope diameter to obtain optimum operational efficiency and avoid premature wear.

- To adjust the jaw width, depress and rotate the top ring counter-clockwise until it is fully opened,
- Install the rope inside the jaw, then press on and rotate the jaw clockwise until the rope should catch into the winch,
- In case of rope slippage, add one or more turns or lock up the top ring.

RUNNING RIGGING - GENOA

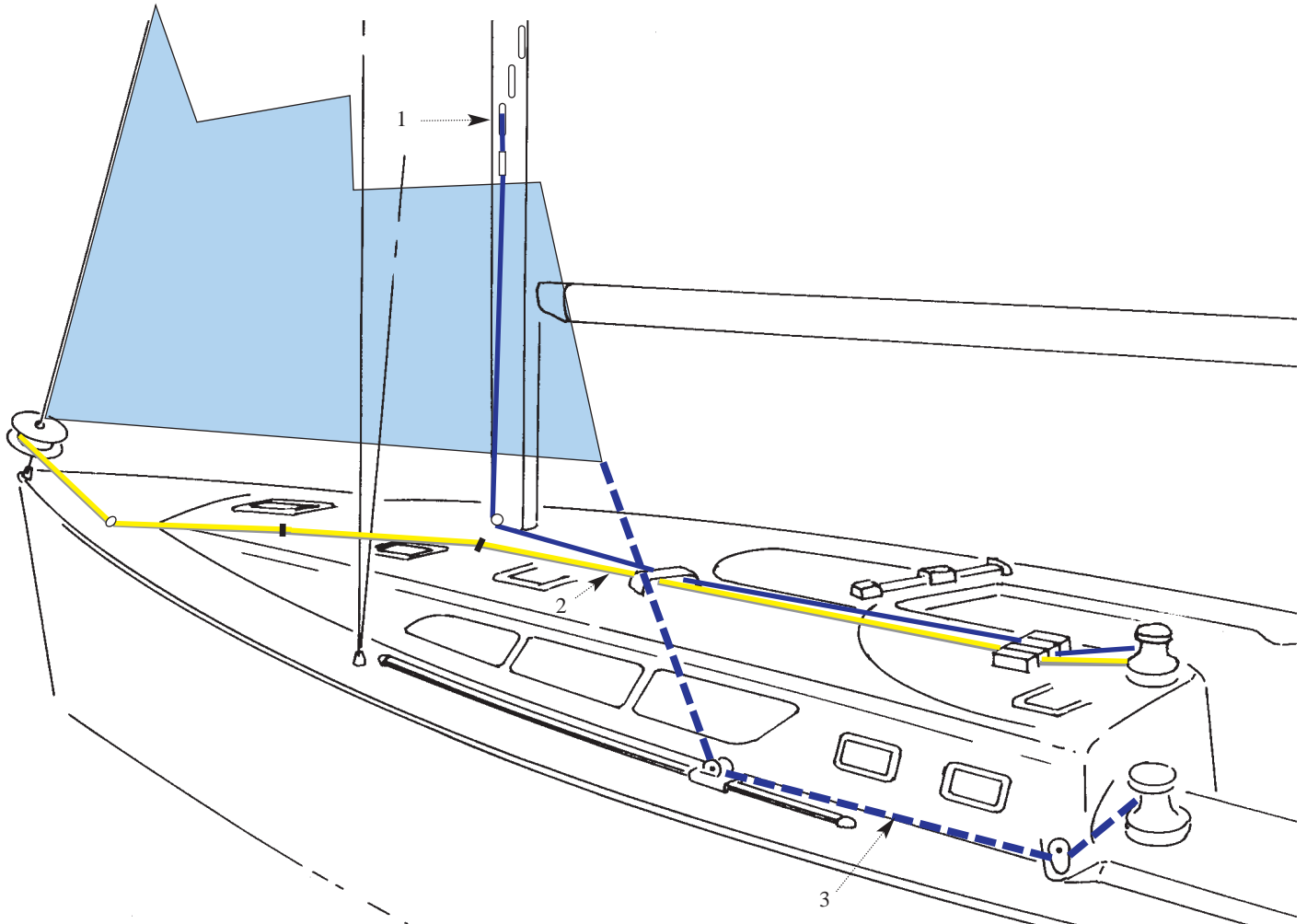

	Rope designation	Nb	Type	Color	Ø(mm)	Length(m)
1	Genoa halyard	1	Braid H	Blue	12	37
2	Genoa furler	1	Braid H	White/Yellow	10	24
3	Genoa sheet	2	Braid H	Blue	14	17
Braid H : Braid halyard						



FURLERS

Before sailing, hoist the genoa in a lull.

- Secure the peak and halyard on the swivel-traveller, and the tack on the drum and sheets,
- Insert the bolt-rope into the feeder. Hoist the halyard taut, but not as strongly as with a sail on a normal stay,
- Pull the stopper from the cockpit to roll up the sail.

Never try to overcome a resistance when rolling up or spreading the sails : ensure that a halyard is not jammed in the furler.

To hoist the main, proceed as for the genoa.

MAINTENANCE :

- Regularly rinse the drum and swivel,
- Grease the bearings if advised by the manufacturer,
- For extended off-service periods, take down the sails.

RUNNING RIGGING - SPINNAKER

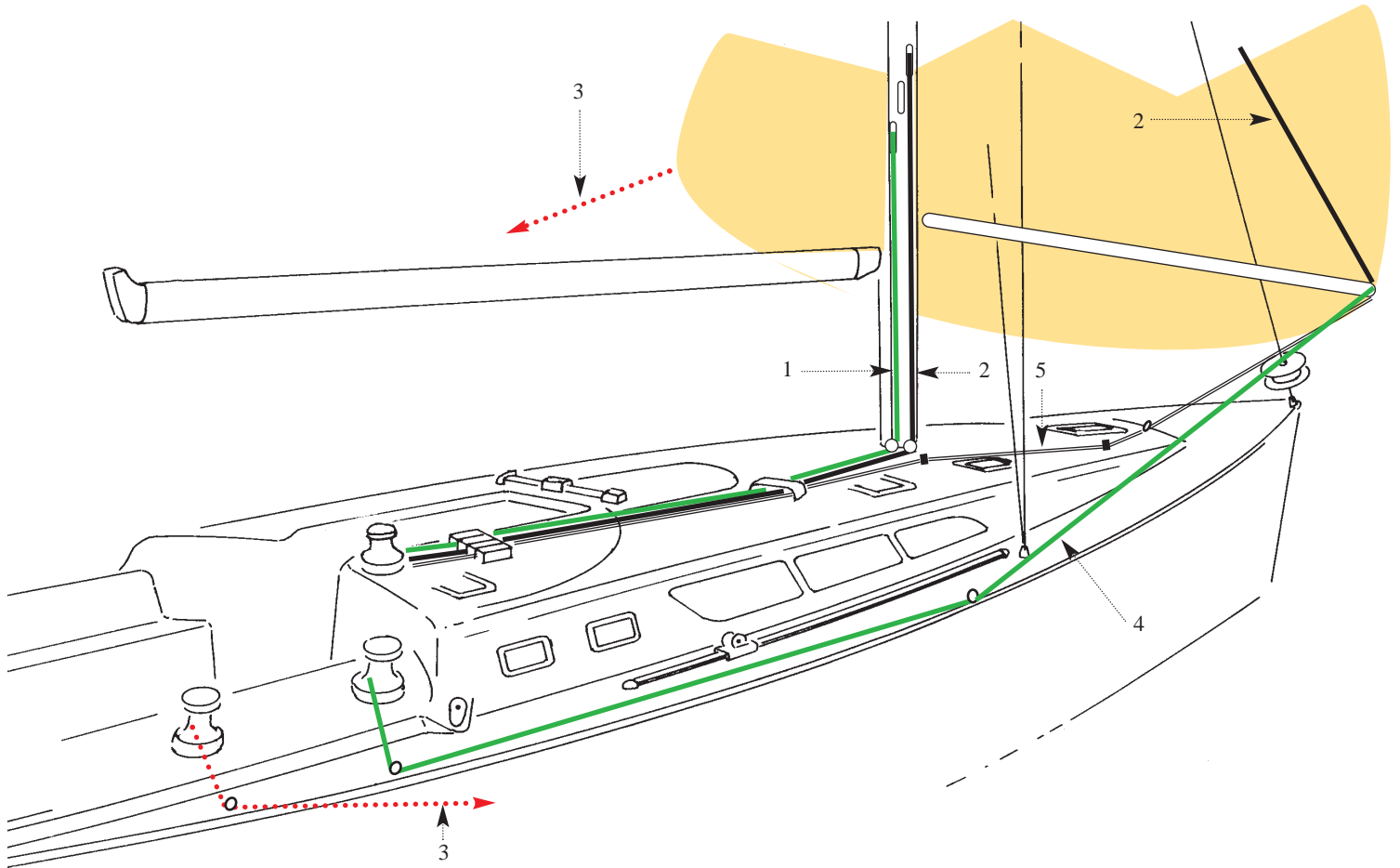

	Rope designation	Nb	Type	Color	Ø(mm)	Length(m)
1	Spinnaker halyard	1	Braid H	Green	12	40
2	Spi pole lift	1	Braid H	Black	10	39
3	Spinnaker sheet	2	Braid H	White/Red	12	24
4	Spinnaker guy	2	Dynema	Green/Black	12	24
5	Spinnaker pole downhaul	1	Braid H	White	10	18
6	Spinnaker pole car adj.	1	Braid H	White	8	10
Braid H : Braid halyard						



SAILS

To a large extent, the life of a sail depends on regular maintenance. As soon as the sailing season is over and, preferably, before winter, leave your sails to a sail-maker to obtain efficient maintenance and repairs.

Set the sails properly at sea in order to achieve the optimum adaptation to the forces to be taken and reduce harmful stresses on the fabrics.

Avoid wear and tears by means of chafing pieces on pointed accessories (spreaders, stanchions, etc...).

Between two trips at sea, don't forget to slack off the halyards on sails on furler and main sail foot.

Obtain a sail-maker's kit and instructions to find out how to perform emergency repairs pending assistance by a sail-maker.

CLEANING AND MAINTENANCE :

Rinse the sails with fresh water from time to time and dry as soon as possible (mould fungus is there to stay).

Don't dry the sails in the lee on the mast, since shaking wears away the seams and the sail may be torn off by the rigging.

All stains can be removed with trichloroethylene but rinsing with water is mandatory.



SAILS

SAILS STOWAGE/FOLDING :

Avoid storing wet sails to obviate fungus.

Fold the sail parallel with the foot, than roll it up to the bag dimensions.

PROTECTION :

UV rays are harmful to polyester and nylon. Where the sails remain on the mast, even for 24 hours, they must be protected by a cover or special fabric on rolled-up leeches and feet.

Our agents' network will offer accessories which have been selected by the shipyard and consistent with your requirements.

ACCOMMODATIONS



MAINTENANCE

FABRICS

2 CABINS VERSION

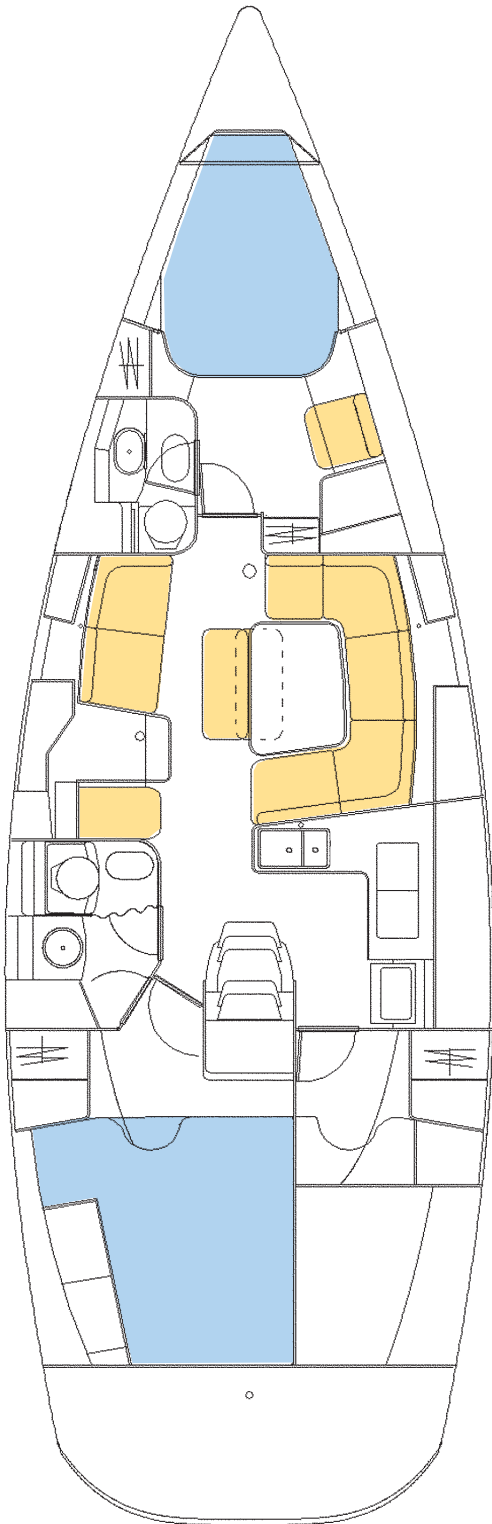

3 CABINS VERSION

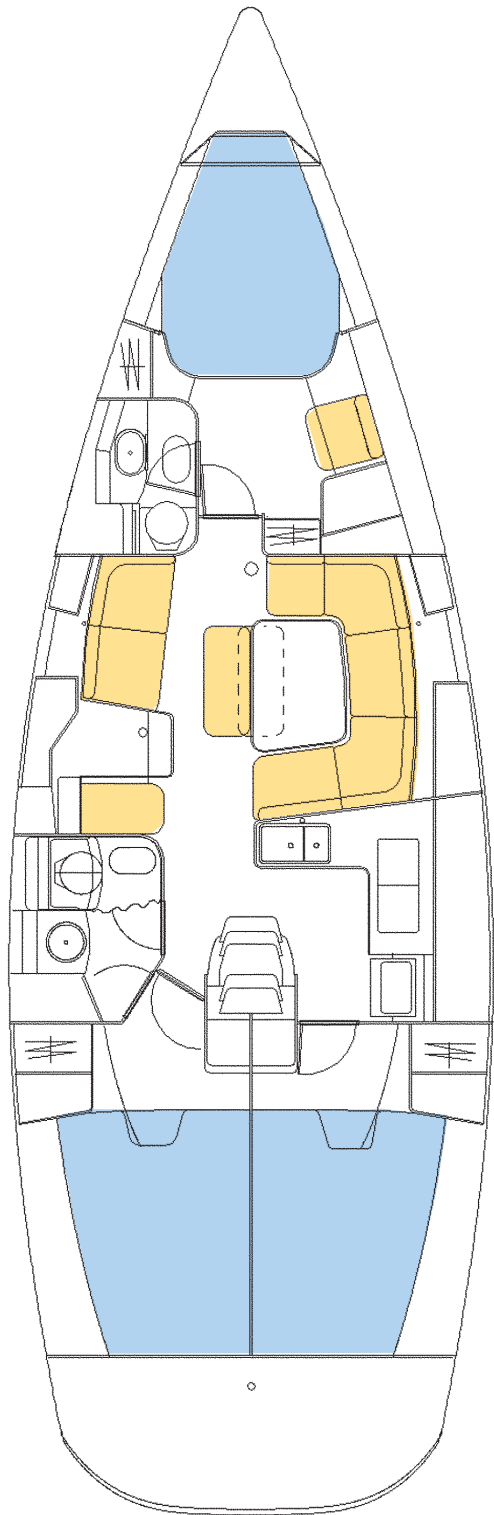

CONVERTIBLE AFT CABIN

Refer to procedure page 35-recto



MAINTENANCE

INSIDE :

- Take advantage of fine weather to raise and ventilate the cushions when you leave your boat,
- Use blinds to protect the inside of your boat from UV rays,
- Bred crumps must be systematically eliminated,
- Ensure that the bilges are cleaned and dry.

INSIDE VARNISH :

- Rinse inside varnish with degreasing shampoo mixed with fresh water,
- Polish inside varnish with shamoy leather.

RECOMMENDATIONS

Use the less cleaner products as possible and do not thrown them out in the sea.
Clean preferably your boat on shore.

4 CABINS VERSION

3 CABINS VERSION

CONVERTIBLE FORWARD CABIN

Refer to procedure page 36 & 36-recto

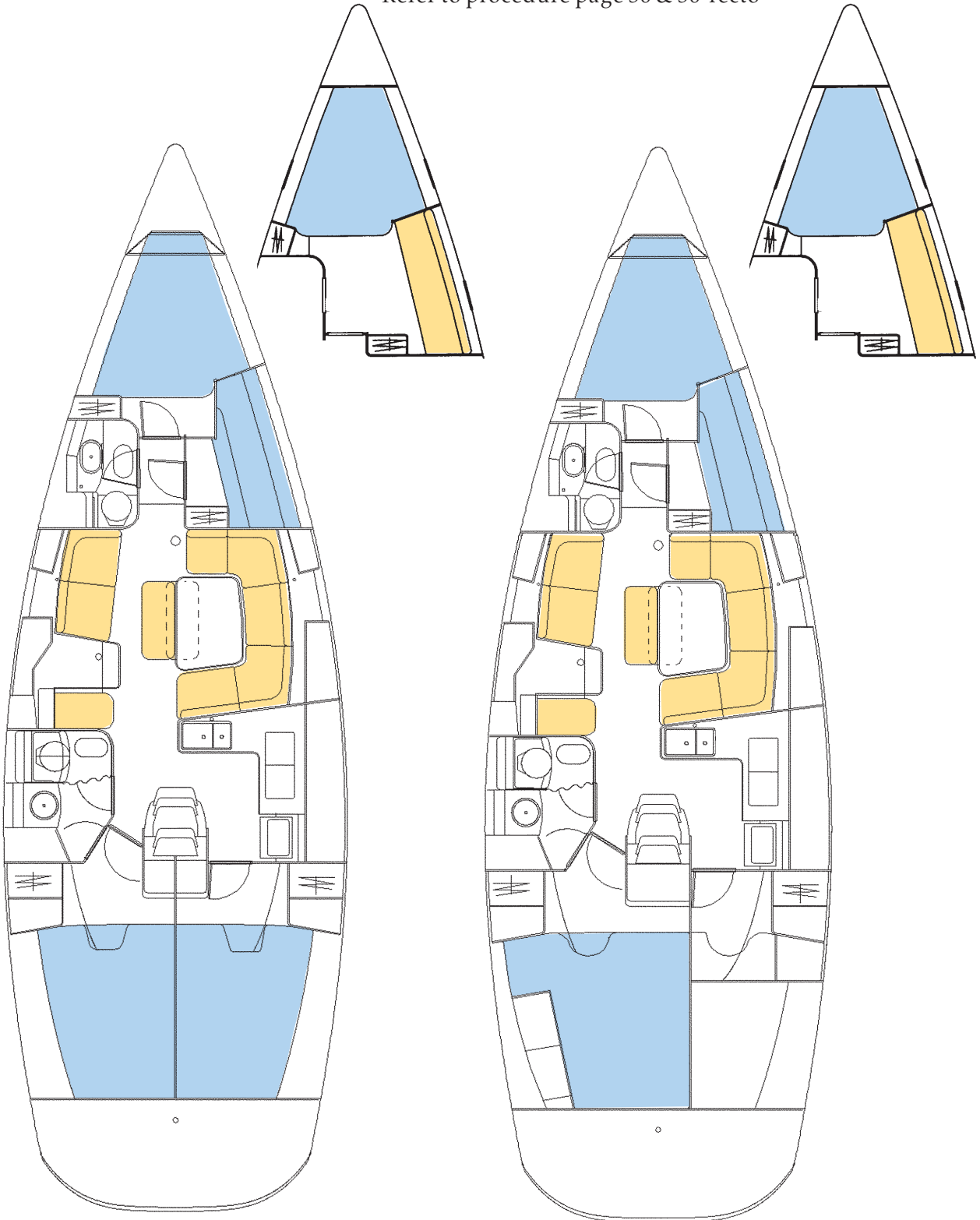

CONVERTIBLE AFT CABIN

Refer to procedure page 35-recto



FABRICS

RECOMMENDATIONS

Mark up each cover and foam cushion on dismantling.

- Stains :

Remove as much of the stains as possible with a knife blade moving from the edge towards the center.

Dab with clean rags.

Remove the stains using clean rag and a solvent (never pour solvent directly over the stains).

Rub with a clean and dry rag, than brush the fabrics against the pattern.

Clean with a vaccuum cleaner when dry.

- Coated or PVC fabrics :

Use a sponge and soapy water (Olive oil soap type).

Dab away stains, without rubbing, with a white spirit soaked cloth.

PRECAUTION

Solvents or solvent based products (pure alcohol, acetone, trichloroethylene) are striclty prohibited.

AFT CABIN CONVERSION

Version:
2 aft cabins



1 - Remove the mattresses.



2 - Remove the starboard engine trap door.



3 - Dislodge the central bulkhead (fixed with «velcro») pulling the handle.



4 - Dislodge the bulkhead section above engine.

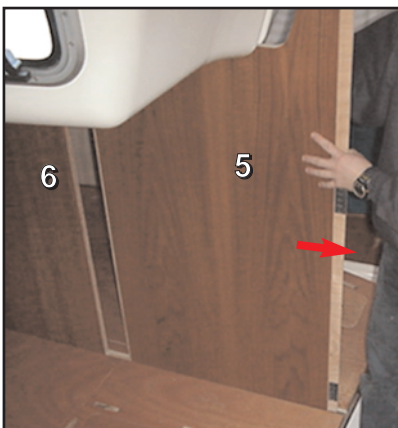

5 and 6 - Dislodge the bulkhead sections above the berth.

7 - Put ashore the various bulkhead sections.

8 - Put back the mattresses in place



FABRICS-

- 100% polyester Jackard/Dralon :

If you can't remove the cloth : clean with a vacuum cleaner, wash with synthetic foam adhering to the manufacturer's instructions.

If you can remove the fabric: hand wash with a commercial lye at 30°C.

In both cases, dry cleaning is possible. Remove stains as soon as possible with moist rags.

- Cotton Jackard :

Dry cleaning.

Do not iron.

Do not use chlorine.

Remove stains with fractionated petrol.

- Alcantara :

Wash in lukewarm water with neutral soap.

Allow to dry.

Dry clean with perchlorethylene.

- Leather :

Use special leather paste for routine maintenance.

Never use any detergent nor silicone-based products.

Clean with a sponge and soapy water.

Remove all ball pen stains with methylated spirits and grease stains with «terre de Sommière» application.

RECOMMENDATIONS / MAINTENANCE :

The ship-builder has tested and approved a number of biodegradable maintenance and renovating products which protect the material and environment.

The relevant data sheets are available at our agents who can obtain the information from our company.

FORE CABIN CONVERSION



Version : 2 fore cabins



1 - Take the central cabin door off its hinges.



2 - With a Phillips screwdriver, remove the wood covers and mark them because they haven't the same size.

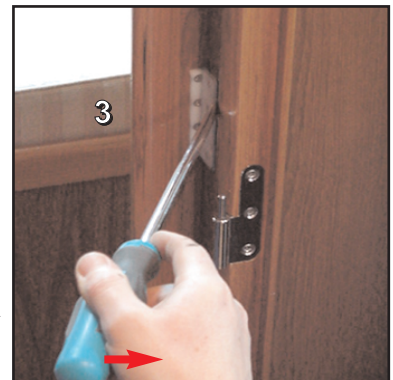

3 - With a screwdriver, unlock all the metallics brooches.



4 - Push with the foot the cabin door bulkhead to dislodge it. Put it aside.

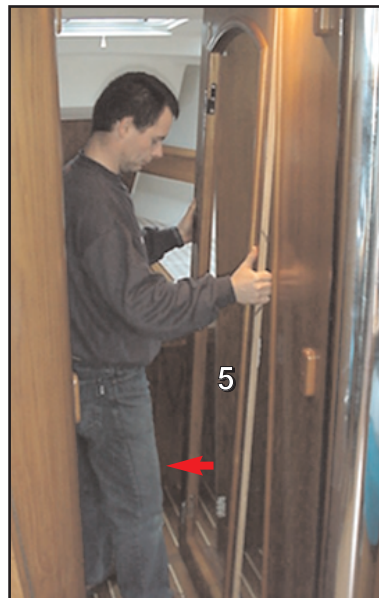

5 - Dislodge the lateral cabin door frame. Put it aside.



6 - Dislodge the fore lateral bulkhead. Put it aside.

FORE CABIN CONVERSION



7 - Unlock the bolt on the upper berth.



8 - Unlock the bolt at the foot of the bulkhead.



9 - Dislodge the lateral bulkheads. These bulkheads are broached together. Put them aside.

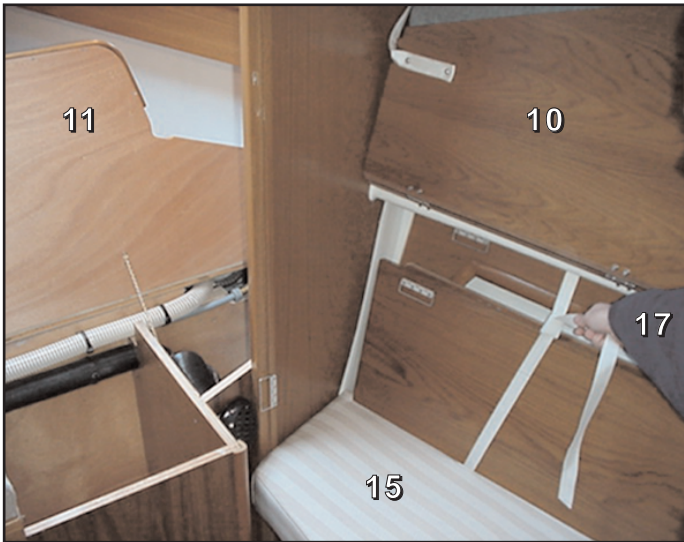

10 - Fold the upper berth.

11 - Open the starboard fore locker.

12 - Remove the lower mattress.

13 - Prepare the supporting straps.

14 - Put first the bulkhead nbr 5.

15 - Put back the lower mattress in place.

16 - Put the bulkhead nbr 6 and then 9.

17 - Step up the bulkheads.



18 - Unlock the upper berth support strap snap hook.

19 - Turn the berth into seat back.

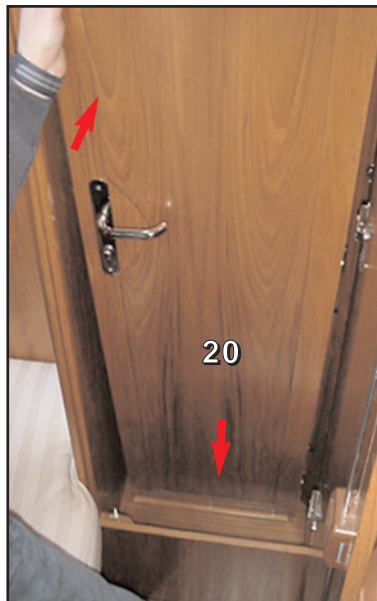

20 - Put the door 1 in the hanging locker : Wedge it in the snicks and fasten it with the shockcord.



21 - Take the door 4 off its hinges to position the door frame.

22 - Broach the door frame and screw the covers (see 2).

23 - Hinge the door.

indice 0

PLUMBING



WATER TANK FILLING

FRESH WATER SYSTEM

GAS SYSTEM

WATER DISCHARGE

SANITARY APPLIANCES OPERATION

FRESH WATER

- 1- Tank breather
- 2- Water tank
- 3- Deck filler
- 4- Mixer tap
- 5- Hot water hoses
- 6- Cold water hoses
- 7- Water tank select valves
- 8- Fresh water filter
- 9- Water meter
- 10- Water pressure unit
- 11- Accumulator tank
- 12- Shower
- 13- Water heater
- 14- Engine cooling fluid hoses
- 15- Hot water inlet available
- 16- Deck transom shower
- 17- Bilge pump (Refer to Drainage)
- 18- Filtre de pompe de cale (Refer to Drainage)

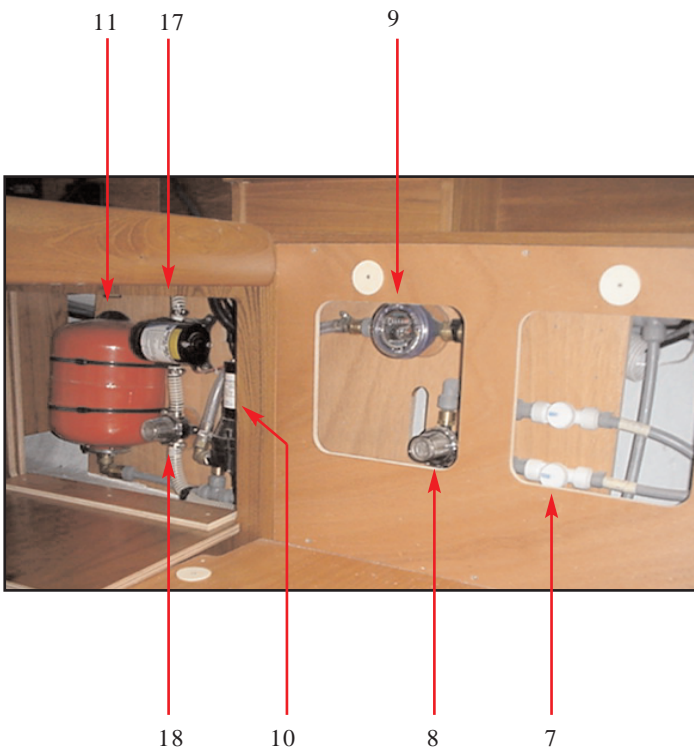
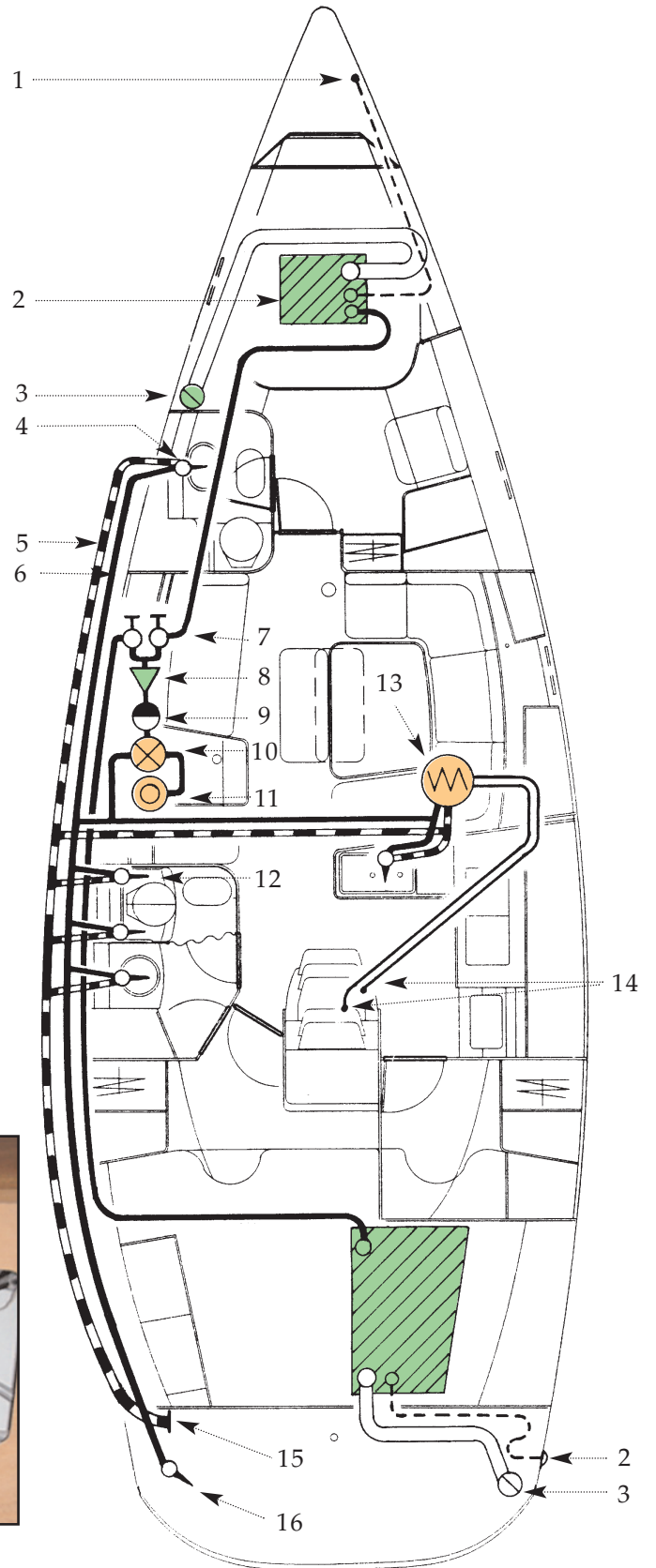

Same place for other accomodation versions



WATER TANK FILLING

In order to obviate any handling mistake, never fill the water and fuel tanks at the same times.

During filling, avoid handling contaminants near the filling plugs.

Open and close the filling plugs with the special spanner.

Check the filler plug seals for condition during filling.

The tanks are fitted with overflow outlets and vents.

To prevent a pressure build-up in the system, never press the water filling hose deep into the system.

RECOMMENDATIONS / MAINTENANCE

The tanks can be sterilized by adding a “clonazone” tablet (available from chemists).

Purify the tanks and pipes with acetic acid or white vinegar if the boat is to stay unmanned for a long period.

Inspection ports are provided on tanks through which internal cleaning can be performed.

Refer to chapter 11 for winter precautions.



Closed seacock



Open seacock



FRESH WATER SYSTEM

plumbing

PRECAUTION

Never run the water system if the valve is closed or the tank is empty to avoid damaging the electrical equipment. Check the water filter for condition as instructed in the manufacturer's manual.

GAS SYSTEM

(Refer to Chapter 2 « Safety »)

Refit the cap in place on the pressure reduction valve screwed section to avoid corrosion, when changing the cylinder.
Change the hose on schedule.

RECOMMENDATIONS

Don't forget to shut off the gas safety valve and pressure reducing valve when the heater is not in use.

DRAINAGE & GAS SYSTEM

- 1- Seacock with valve
- 2- Electric pump
- 3- Filter
- 4- Sea water intake hose
- 5- Drainage hose

- 6- Sump electric pump
- 7- Manual bilge pump in cockpit
- 8- Water heater
- 9- Water heater drainage valve
- 10- Icebox drainage
- 11- Gas circuit valve
- 12- Gas hoses
- 13- Gas bottle

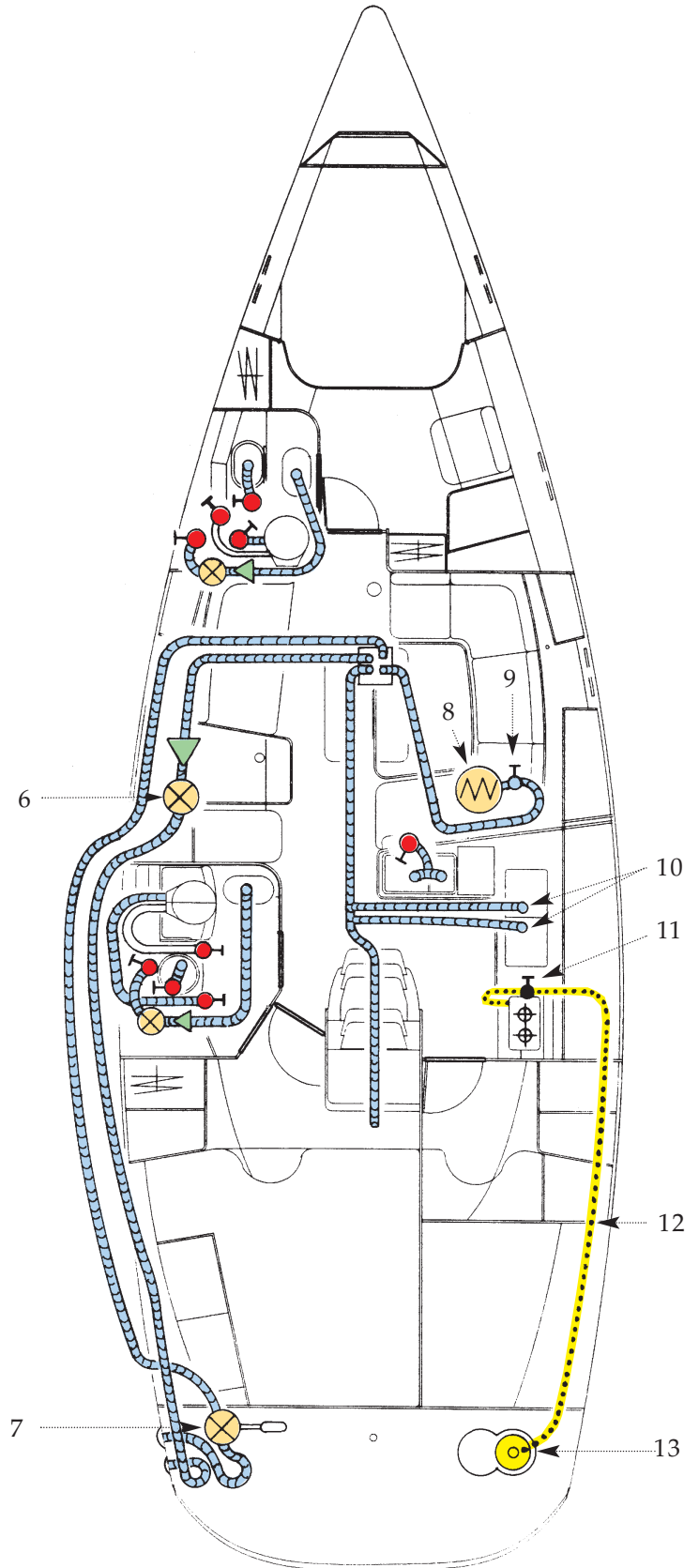

Same place for other accomodation versions



WATER DISCHARGE

Waste water from the sink, wash basins and the closets is discharged by sea chests, fitted with quarter turn valves (when the valve handle is perpendicular with the pipe, the valve is closed, and open when along the pipe centreline).

All floors include water courses (limber holes). (A waterproof carter under the engine receive the possible oil leaks).

A main sump located above the ballast collects the water from the floor and is drained by means of an electric pump or the manual pump in the cockpit.

RECOMMENDATIONS / MAINTENANCE

Check the valves and sea cocks for water tightness and operation regularly.

Shut the valves when the system is not in use.

Check the clamps and hose pipe couplings and seals for condition.

Ensure regularly that the bilge and strum-boxes are perfectly clean.

If one pump should be running while all water supplies are shut,
switch the power off immediately.

Check the water system and eliminate the breakdown.

BATHROOM DRAINAGE PRINCIPLE

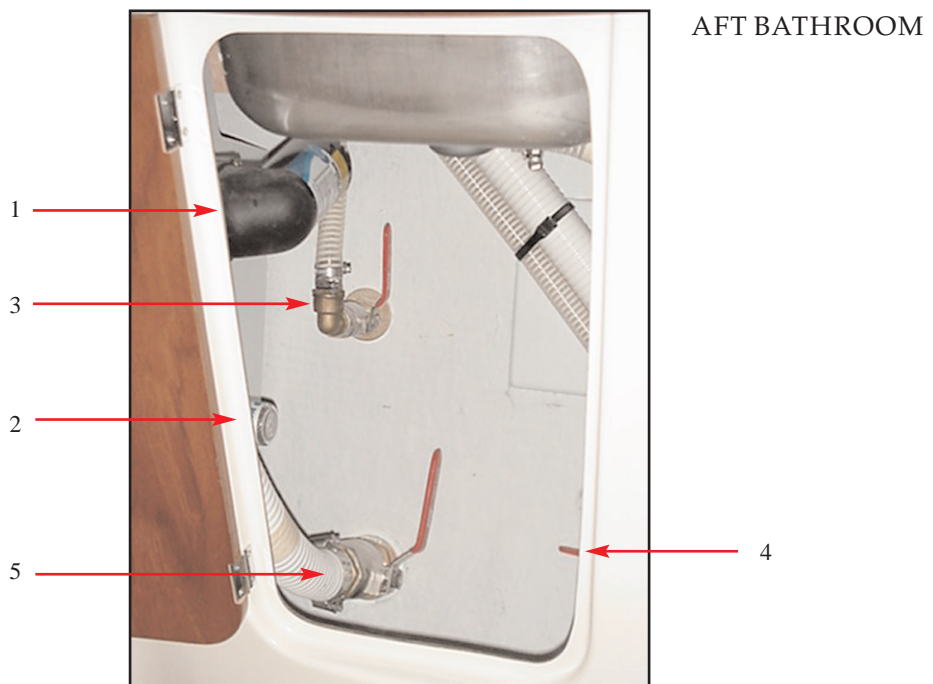
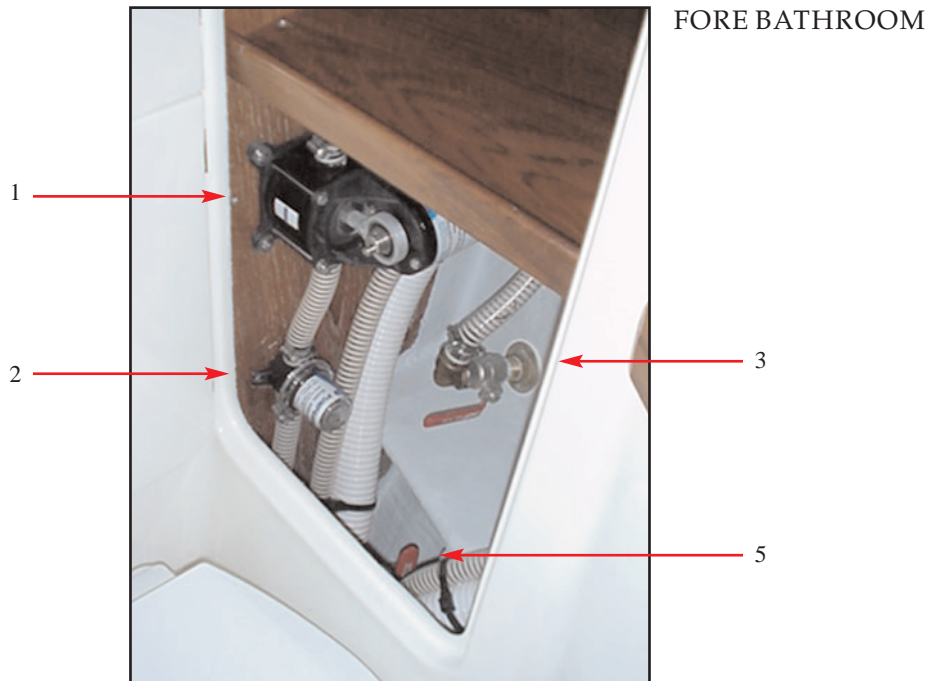

- 1- Shower tub drainage
- 2- Filter
- 3- Seacock with valve, shower outlet pipe
- 4- Seacock with valve, sink outlet pipe
- 5- Seacock with valve, sea water intake for closets



SANITARY APPLIANCES OPERATION

MARINE CLOSETS OPERATION :

Ensure that the water supply and discharge valves are open before using the appliance. To drain the bowl, set the pump lever to "FLUSH" and actuate the pump. To strip the bowl, set the pump lever back to "DRY" and actuate the pump.

Use exclusively absorbing paper to avoid clogging the closets and rinse the system regularly with fresh water.

Shut the valves after every use and especially when the boat is unattended.

WASH BASINS AND SHOWERS OPERATION :

The valves and cocks should be closed after use. To drain the shower tub, actuate the pump switch.

RECOMMENDATIONS

During shore stay, use if possible the club-house sanitary appliances.

Waste water rejection is restricted in some country or marina ;

Waste tank is necessary.

WIRING



BATTERY MASTER SWITCHES

BATTERIES

OPERATION

230V CIRCUIT

SHORE POWER CABLE

MAST HARNESS CONNECTION

ELECTRONICS

DRAWINGS & DIAGRAMS (end of chapter)

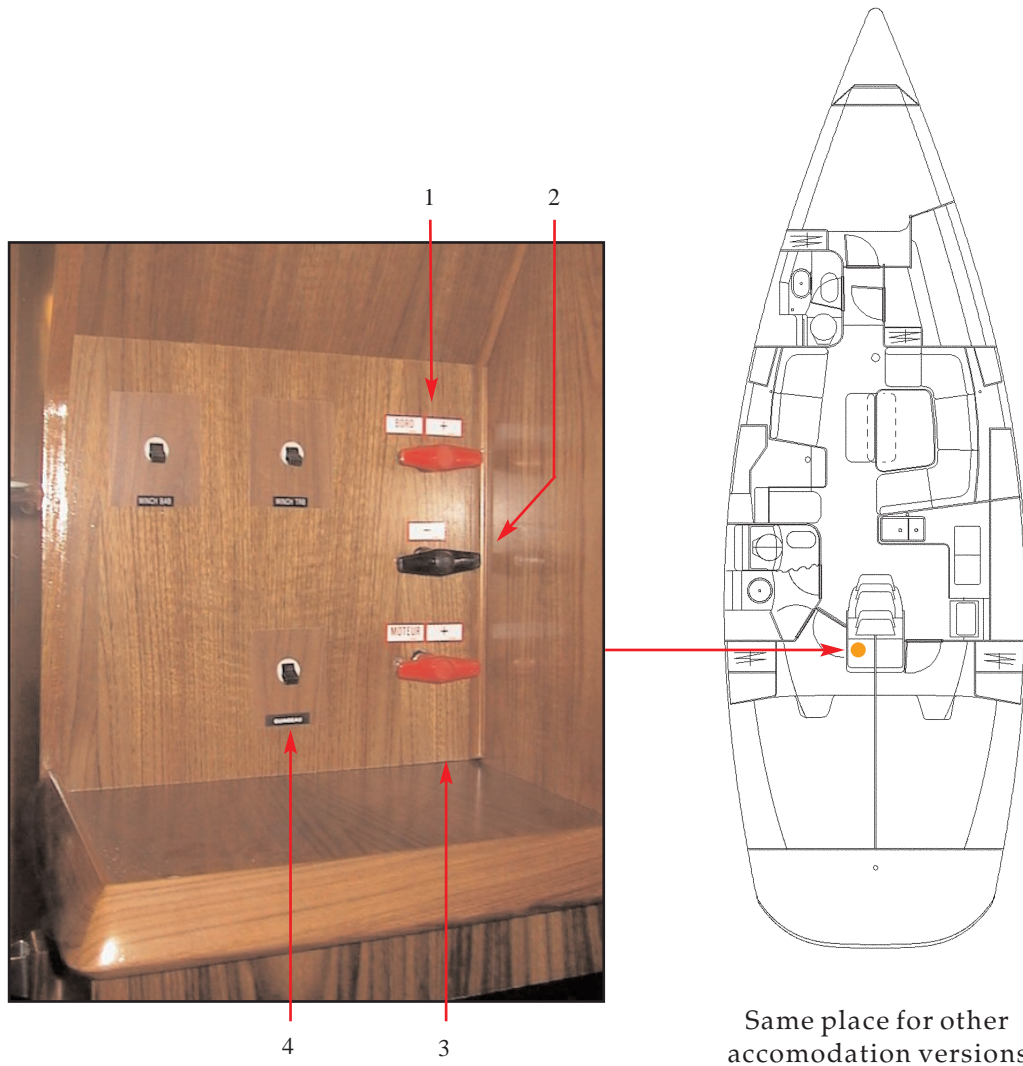

Same place for other accomodation versions

- 1- Battery master switch : + Domestic
- 2- Battery master switch : -
- 3- Battery master switch : + Engine
- 4- Windlass circuit breaker



BATTERY MASTER SWITCHES

Electric installation : 12V DC.

The circuits can be used simultaneously or separately should the need arise.

Turn the master switches on to energize the system.

The master switches energize the engine and house electrical systems.

PRECAUTION

Shut all master switches if the boat is unattended.

BATTERIES

The engine driven generator is used to charge the batteries.

Use your battery charger (optional extra) during shore stay in order to sail off with properly charged batteries.

Never drained beyond 70% of the rating, to ensure a satisfactory service life.

Always check the condition of both the batteries and the loading system before you set sail.

RECOMMENDATION / MAINTENANCE

- Keep the batteries clean and dry to obviate premature wear,
- Check regularly the electrolyte and top up with distilled water if required,
- Check the acid degree in the battery after extended idle time,
- Secure and smear regularly the terminals with petroleum jelly,
- Disconnect the batteries and remove them for the winter storage or when they are not used for a long time.



OPERATION

The electrical switchboard does not require any routine maintenance.

PRECAUTION

Never leave the boat unattended when the electrical system is energized, except for automatic switch bilge pump and protection circuits against fire or robbery.

Disconnect the 230V before opening the electrical switchboard.

In case an electrical unit should not be energized, check :

- The main power supply (batteries, master switches),
- The switches and fuses along the line,
- The relevant electrical unit.

WARNING

Never work on a live electrical fitting.

Use the automatic reset switch to read the fuel gauge, to obviate electrolytic problems.

PRECAUTION

Only a technician, skilled in marine electricity, is entitled to alter a fitting and the relevant diagrams.

Never change or alter the amperage of the overcurrent safety devices.
Never install or replace the electrical appliances or equipments by components exceeding the circuit amperage (Watt for bulbs).

230V CIRCUIT

As far as possible, use electrical appliances with a double insulation or three conductors. Connect the casings or metallic cases of the fitted electrical appliances to the earth of the boat : this conductor is green with yellow stripes.



SHORE POWER PLUG

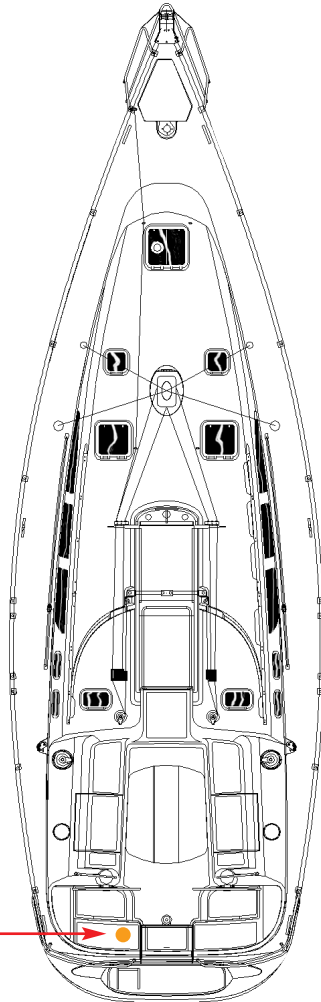



SHORE POWER CABLE

DANGER

Never let the end of the shore power cable hang in the water. It may entail an electric field liable to hurt or kill people swimming close by.



wiring

PRECAUTION

- In order to reduce the risks of electric shock and fire :
- . Switch off the electric panel connected to the shore power plug on shore before you connect or disconnect the shore power cable.
 - . Connect the shore power cable in the boat before you plug it in the power point on shore.
 - . Disconnect the shore power cable first on shore side then close tightly the power point on shore.
 - . Do not change the connections of the shore power cable.

MAST HARNESS CONNECTION

Connect the harness after installation of the mast.
Access to the harness can be gained through the pillar boxing in the forward cabin, after inserting them in the cables outlets in front of the mast step.

ELECTRONICS

Special sleeves are available to complement the boat's equipment (refer to drawing).
Never install electronic instruments or repeaters less than 1.50m away from the radio loudspeakers.

DIESEL ENGINE



FUEL TANK

FUEL FILTER

FUEL CIRCUIT VALVE

ENGINE

DASH BOARD / CONTROL LEVER

STUFFING BOX

PROPELLER

ANODE

ENGINE INSTALLATION

- 1- Engine
- 2- Exhaust muffler
- 3- Fuel return hose
- 4- Fuel circuit valve
- 5- Tank
- 6- Vent
- 7- Deck filler
- 8- Engine compartment air exhaust
- 9- Engine seacock
- 10- Sea water filter
- 11- First-stage filter
- 12- Fuel return hose
- 13- Exhaust pipe
- 14- Engine compartment air intake

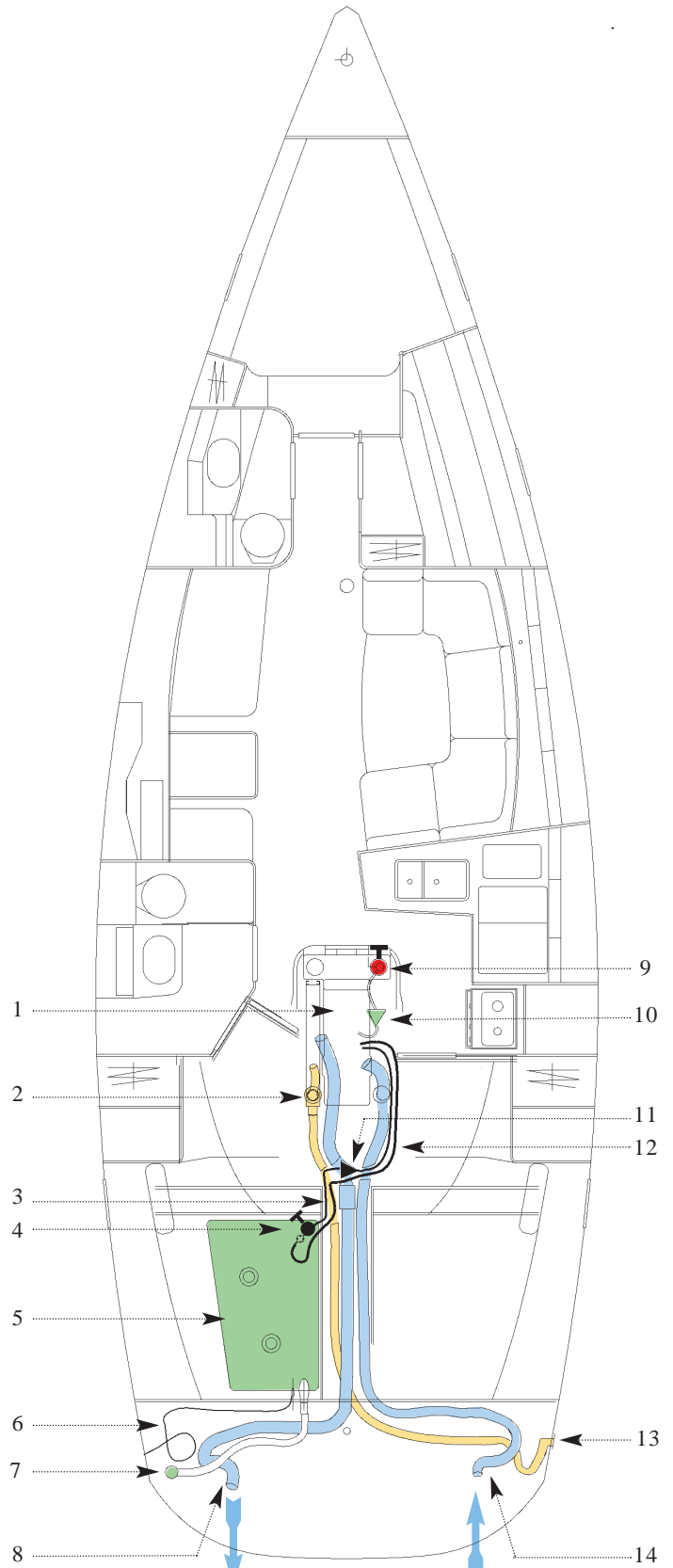
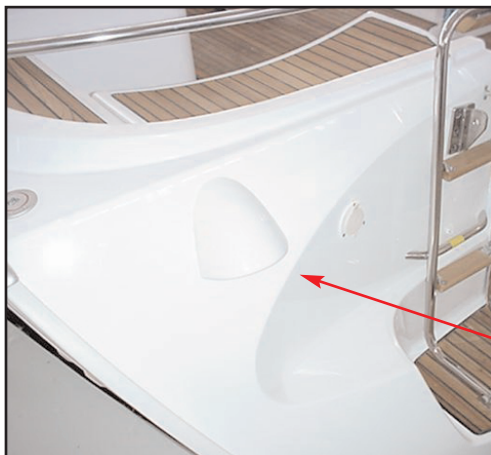

Same place for other accommodation versions



FUEL TANK

TANK FILLING :

Comply with the general precautions indicated in chapter 7 for tank filling.
To protect the deck from possible fuel splashes, wet up the area around the deck filler with sea water before taking the plug off. In case of splashes, rinse the deck liberally (after fitting the filler plug back in place).

DANGER

During fuel tank filling, the engine must be stopped and smoking must be prohibited.



diesel engine

RECOMMENDATIONS / MAINTENANCE

- Check regularly the filler plug O-ring for conditions to prevent water ingress,
- Don't shut the fuel valve after every utilization, except before an extended unattended period,
- Ensure that the tank is full up to maximum, to avoid condensation,
- Clean the tank every five years to remove sludge deposits.

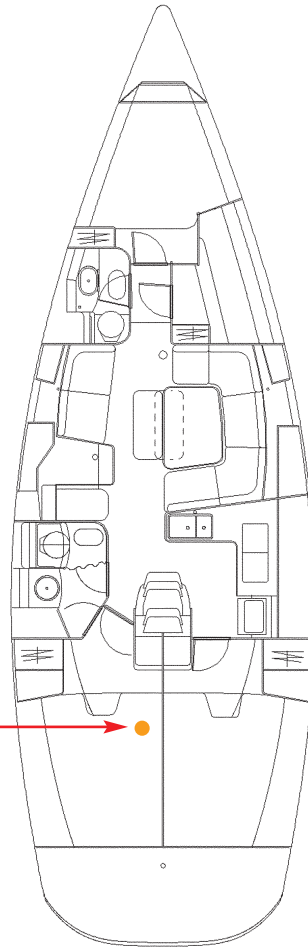
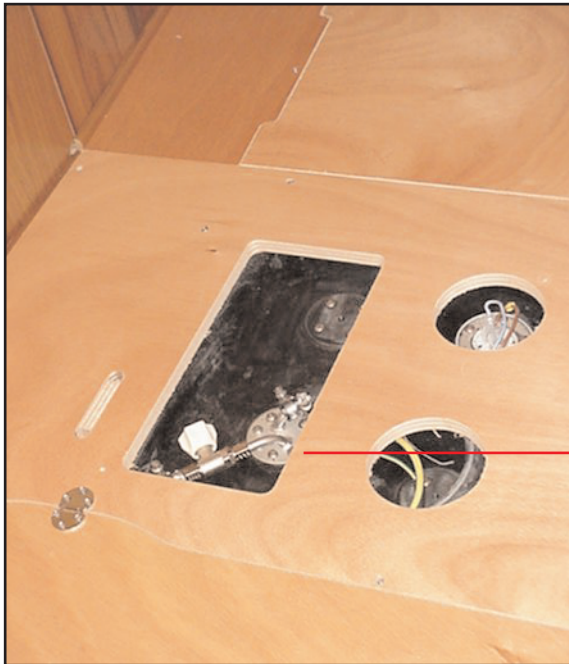

Same place for other
accomodation versions



FUEL FILTER

Engine running problems may have several causes, amongst which dirty fuel is a major one, and the injection pump will be soon destroyed by water in the fuel.

Water results either from the condensation in an insufficiently filled tank, or seeps in through the mislocked filler plug or through a damaged seal.

The fuel is run via two filters to control the foregoing risks :

- One filter is integral with the engine to ensure fine fuel filtration (refer to the engine brochure to find out the filter renewal frequency and maintenance work),
- The other one is a first-stage filter located in the pipe system between the engine and the fuel tank.

Undo (but do not remove) the knurled screw at the base of the settling bowl, allow to flow into a tray until clean, water free fuel appears. Purge the system several times a year. Remove the bowl for access to the first-stage filter, which should be replaced at least once a year.

FUEL CIRCUIT VALVE

See chapter 2 for Fight against Fire

DANGER

Never obstruct the ways to the fuel valve.

diesel engine



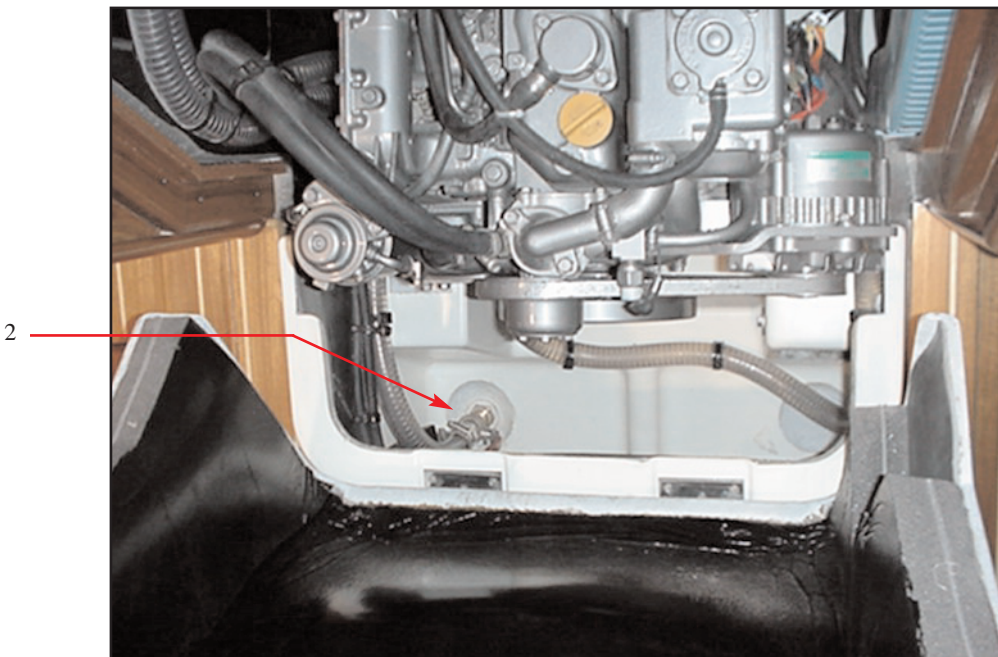
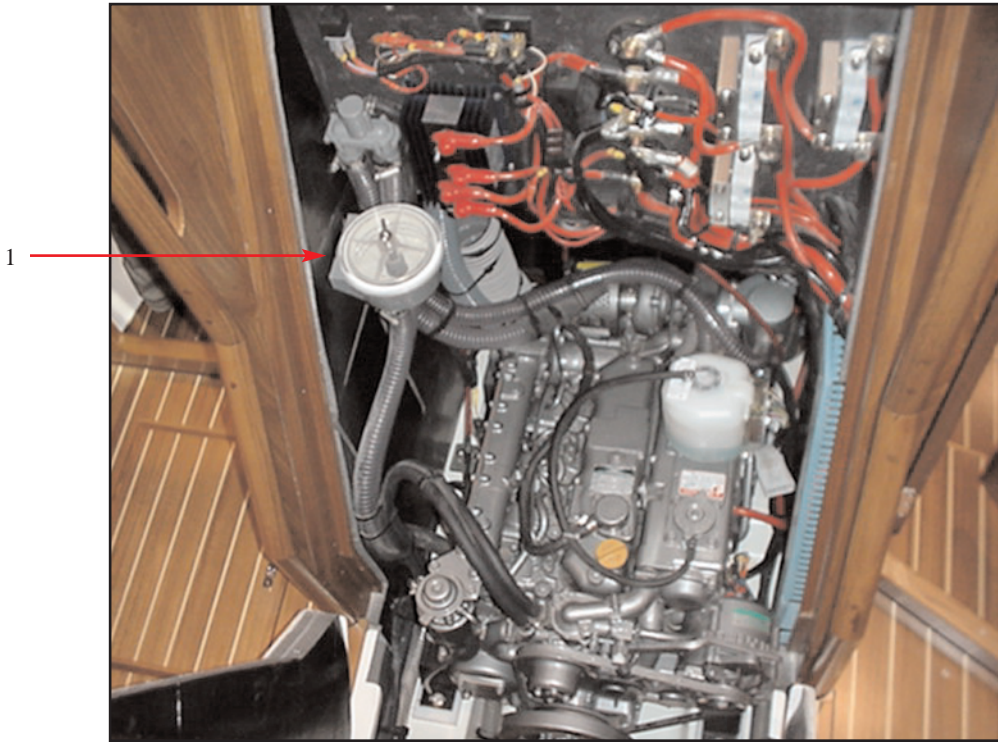

1 - Cooling water filter

2 - Seacock with valve, engine sea water intake



ENGINE

Refer to the brochure supplied with the boat.

You must read carefully the brochure which includes detailed hints about the engine operation and how to run it properly.

PRECAUTION

Never run the engine if the boat is dry-docked.

ACCESS TO THE ENGINE :

Access to the engine via the companionway panel.
Lateral trap doors give access to the principal instruments.

ENGINE SEA VALVE :

The engine sea valve ensures a critical duty in the engine operation and, therefore, the strainer must be brushed whenever the ship is docked and kept clean and free from clogging or anti-fouling paint.

The sea valve must be open before starting the engine, otherwise the exhaust and the engine may incur severe damages.

RECOMMENDATIONS

Good practice requires to check if water is expelled together with the exhaust gases, immediately after starting the engine; otherwise, stop the engine immediately and check the valve for cleanliness.

It's not necessary to shut the valve after each use of the engine; on the other hand, this is mandatory if the boat remains unmanned for a long period of time.

Check and clean the water filter regularly.



ENGINE OPERATION :

Before starting the engine :

- Open the fuel valve,
- Open the engine cooling valve,
- Actuate the battery master switch to energize the electrical system,
- Before starting the engine, disengage the reversing gear to accelerate from dead stop,
- Refer to the engine manufacturer's brochure before starting up the engine.

PRECAUTION

Don't turn off or de-energize the electrical system while the engine is running .
If your boat's diesel engine is fitted with a stop pull,
this must be actuated before using the ignition key to switch off.

DIESEL :

- Refill before the fuel tanks are depleted to prevent the fuel system from running dry,
- Before sailing be sure to have enough fuel.

RECOMMENDATIONS / MAINTENANCE

Refer to the manufacturer's brochure supplied with the boat.
Look after all eventual risk of oil or fuel leaks. Check the exhaust gaz colors.

DASH BOARD / CONTROL LEVER

All engine controls are located on the dash board, which does not require any special precautions (refer to engine brochure).

Check the accelerator and clutch cables (lubricate the spacers and fork ends).

RECOMMENDATIONS / SAILING

Avoid making noise and waves near other users when the boat is engine-powered ;
Respect speed-limits.
Set the lever Astern to lock the propeller when sailing.
Restarting the engine: Reduce sailing boat speed to declutch the engine,
then turn on the engine.

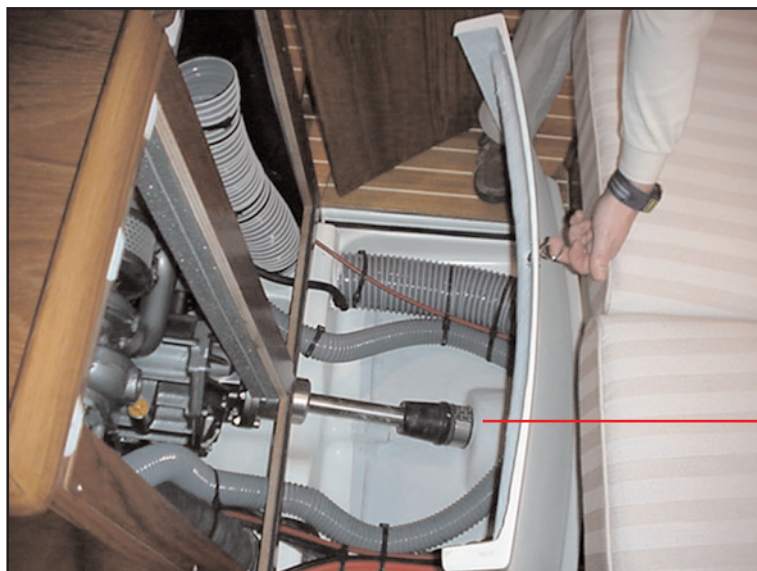

Access for owner's aft cabin version:
Open the engine trap door and lift the floor trap.

Access for 2 aft cabins version:
Dismantle the central bulkhead before lifting the floor trap (see procedure page 35-back).

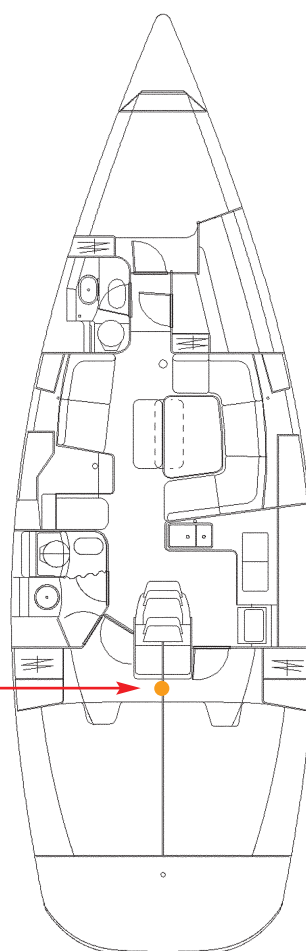

Same place for other accommodation versions

STUFFING BOX

Lubricate the seal every 200 running hours, or at least once a year with 1cm³ of lubricant. After launching, discharge the air from the sleeve by pinching with fingers.

PROPELLER

The propeller supplied with your boat embodies the results of tests carried out jointly with the engine manufacturer.

PRECAUTION

Don't change the propeller without specialist's advise.

ANODE

RECOMMENDATIONS

Check regularly shaft line and propeller anode for corrosion and renew as required. Check and replace the "hydrolube" oil ring if necessary.

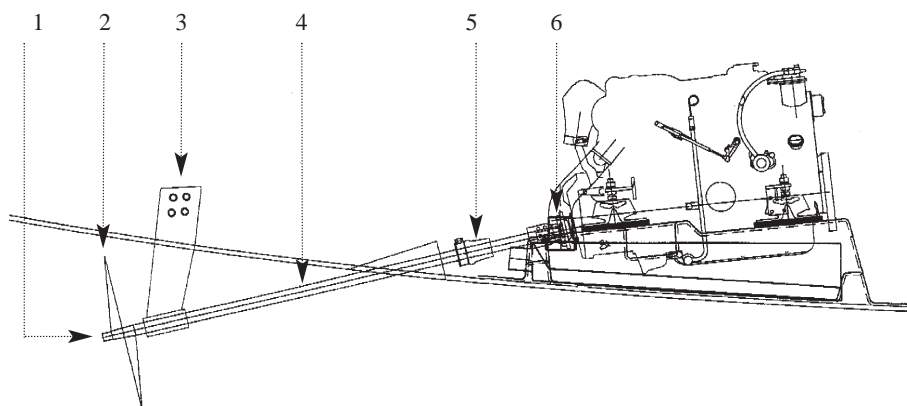

- 1- Anode
- 2- Propeller
- 3- Shaft seat

- 4- Shaft tube
- 5- Stuffing box
- 6- Connecting

LAUNCHING



LAUNCHING HINTS

MAST INSTALLATION



LAUNCHING HINTS

A lot of skill and care is required to launch your Jeanneau boat for the first time, since the satisfactory operation of all equipment will depend on the quality of many launching steps.

Therefore, the initial launching and tests of various equipment shall be performed by your Jeanneau agent or distributor, so you can claim the warranty in case of equipment failure.

The following precautions are required in case you should launch your ship yourself :

BEFORE LAUNCHING :

- If the boat is fitted with a lock and speedometer, install the relevant fittings,
- Check the suction strainer for cleanliness,
- Check the reduction gear and engine oil level (refer to the engine maintenance manual). The engine cooling water drain corks must be shut,
- All optional accessories must be sealed off with paste,
- Retract the speedometer in its housing (this can be damaged by the handling belt),
- On-line engines: ensure that the node is in place and the nut is properly locked (the lock-washer must be folded back on the nut). The anode should not be painted,
- All sea suction and discharge valves must be shut (sink, wash basin, closets, engine).

HOISTING :

- Install a rope forward and a rope aft and fenders as necessary,
- Before hoisting, ensure that the belts will not crush the locks, speedometers, shafts, etc...

To that effect, mark the belt position (adhesive tape on the moulding) for hoisting after launching (most boats are already fitted with the stickers).

The crane hook shall be fitted with a gantry or spreader with two belts. Under no circumstances shall the belts be hooked directly on the hook as this would result in excessive compressive stresses on the hull.

- Hoist up gently and control the boat moves with the ropes.

WARNING

Don't stay on-board or under the boat during hoisting.





AFTER LAUNCHING :

- Check the speedometer and lock fittings for tightness, as the case may be,
- Open and check the valves for sealing with the hull and relevant pipe,
- Check the stuffing box for sealing (refer to section 8 "Stuffing box"),
- Before starting the engine, refer to chapter 8 "Engine".

MAST INSTALLATION

Refer to chapter 5 «Rig and Sails».

LAYING UP AND WINTER PRECAUTIONS



LAYING UP

PROTECTION & MAINTENANCE



There are two winter precautions procedures :

1- LAYING UP

Take ashore all ship's documents, loose ropes not used for mooring, galley equipment, stores, clothes, safety equipment, battery.

Mark up the safety equipment and check the expire dates; obtain immediate overhaul of the raft (Easter is the deadline after which it will be too late !).

Draw up a complete inventory of the ship's equipment.

2- PROTECTION AND MAINTENANCE

INSIDE :

- Drain all fresh water pipes and rinse with a solution of vinegar and water (don't use chlorine-based products) or protect the pipes with food-grade anti-freeze,
- Lubricate and shut all sea water valves and sea-cocks, rinse and drain the closets in full,
- Retract the loch and speedometer heads, seal-off air inlets and install a dehydrator in the saloon and leave all doors open (cabins, lockers, wardrobes, iceboxes),
- Leave the cushions in the outside for a long time and re-install in the boat in upright position to limitate contact surfaces.

OUTSIDE :

- Rinse liberally the hull, deck, lubricate all mobile and mechanical components with petroleum jelly (locks, hinges, bolts, etc.),
- Protect all surfaces from chafing ropes, mooring lines ,
- Protect the boat with fenders and ensure that the lines are taut.

The above hints are not a comprehensive check-list ; your Jeanneau agent will be able to advise you and take care of the boat maintenance.



ENGINE :

Engine winter lay-up shall be performed by a professional organization, and will not be the same if the boat remains afloat or ashore.

The following are a few major tasks :

Afloat :

- Drain the cooling system and fill up with anti-freeze,
- Switch off the master switch, lubricate the terminals with petroleum jelly and test the battery voltage,
- Change the anode,
- Fill the fuel tank to maximum to avoid condensation,
- Refer to the engine manual for everything concerning the engine.

Ashore :

- Take the battery ashore and keep it under maintenance charging,
- Drain all cooling, lub oil, fuel oil and exhaust systems and perform winter precautions specified by the manufacturer, bearing in mind the fact that the freezing hazard is more significant if the boat is ashore,
- Remove and lubricate the sea-cocks included in the cooling systems, leave the sea-cocks open, check the hoses,
- Slack off the pumps and A.C. generators belts.

PERSONAL NOTES



CHANTIERS JEANNEAU - BP 529 - 85505 LES HERBIERS cedex - FRANCE
Tel. (33) 02 51 64 20 20 - Fax : (33) 02 51 67 37 65
3615 JEANNEAU (2,23F / mn) - Internet: [http://www.jeanneau.com\(fr\)](http://www.jeanneau.com(fr)).



The present document is not contractual and constantly desiring to improve our models, we reserve the right to modify them without advance notice.
Conception et réalisation: FLUCAS- NANTES - Impression Numérique : Goubault Imprimeur Nantes0

Jeanneau recommend **IGOL**