

JEANNEAU

53



S U M M A R Y

- > SPECIFICATIONS
- > KEY POINTS
- > EXTERIOR
- > INTERIOR
- > SAILS
- > 360 DOCKING
- > CONSTRUCTION
- > UPHOLSTERY
- > ELECTRONIC PACKAGES



JEANNEAU
YACHTS

Prism *Process*



TECHNICAL INFORMATION

Overall length: 16,06 m / 52' 8"
 Hull length: 15,73 m / 51' 7"
 Waterline length: 13,96 m / 45' 9"
 Beam: 4,77 m / 15' 7"

Displacement: 14.935 kg / 32.926 lbs
 Standard keel draft: 2,28 m / 7' 5"
 Shoal keel draft: 1,80 m / 5' 10"

Cabins: 2 / 3 / 4 / 5
 Berths: 4 / 6 / 8 / 10 + 3

Engine power: Yanmar 100 Hp / 74 Kw
 Fuel capacity: 240 l / 63 US gal
 Water capacity: 950 l / 251 US gal
 Cold capacity: 300 l / 79 US gal

Sail area:
 - Standard 127 m² / 1 366 Sq ft
 - Classic 146 m² / 1 571 Sq ft

CE Category: A13 / B14 / C16 Pers
 Designers: Philippe Briand Yacht Design
 Concept et Design Garroni Premorel - Jeanneau Design

VERSIONS • LAYOUTS

Compatible 360 Docking - POD120

Fixed keel version
 Shoal draft version

2 cabins / 2 heads
 3 cabins / 3 heads
 4 cabins / 2 heads
 4 cabins / 4 heads
 5 cabins / 3 heads
 Skipper cabin

EXTERIOR

This elegant offshore cruiser offers an exceptional interior and deck plan designed by Vittorio Garroni with ease of handling in mind: every detail has been conceived to offer the highest quality cruising experience.

Sailing performance worthy of a Jeanneau Yacht:

- From the drawing boards of Philippe Briand and Garroni Design
- A long waterline and careful weight distribution that ensures speed and seaworthiness unmatched in her class.

INTERIOR

A new style of contemporary interior that reflects a long nautical heritage:

- Rich materials are found throughout including leather, blond teak flooring and stainless steel
- Sleek windows bathe the interior is light.

A level of comfort that you have been seeking:

- Finely appointed cabins, spacious galley and luxurious lounging and dining areas make every moment onboard enjoyable and memorable
- Large choice of layouts

WELCOME TO THE WORLD OF JEANNEAU YACHTS



DECK

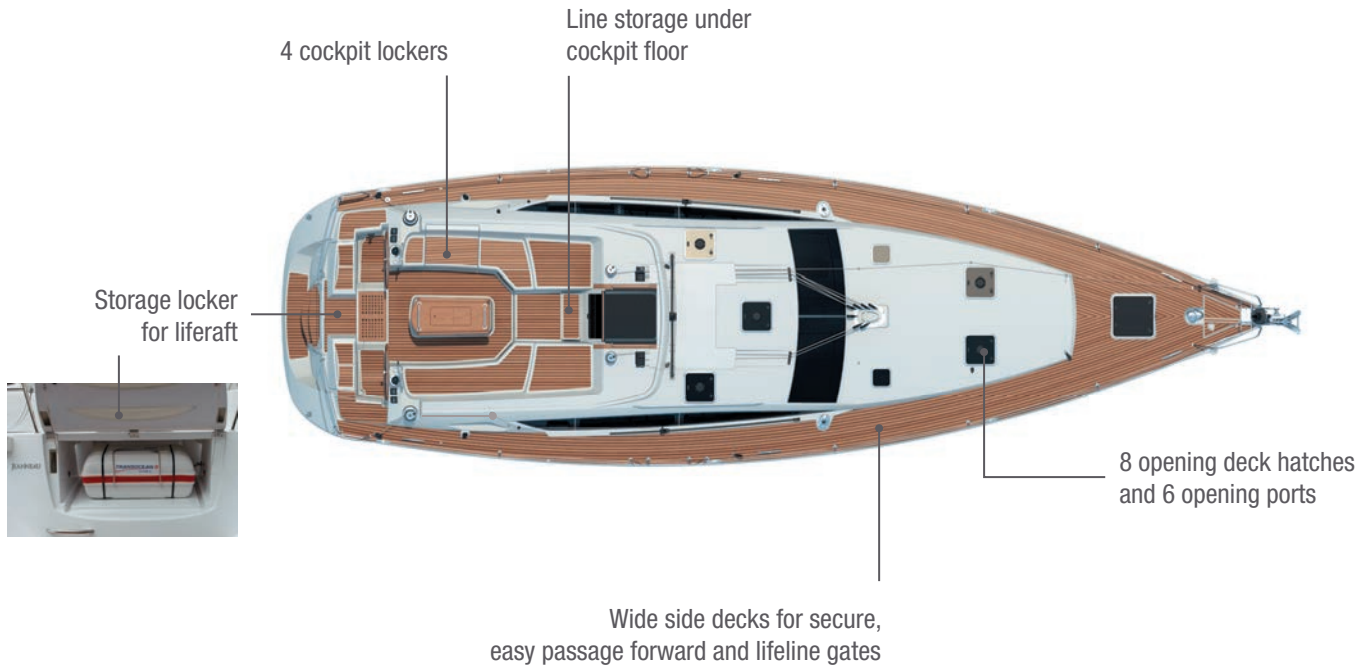

DECK (continued)

Lounging area



Large and deep transom



Domed ceiling in aft cabins with opening ports extends under the cockpit table and provides headroom, ventilation and light

Long Harken traveller



Companionway door slides into cockpit floor for easy storage

DECK (continued)

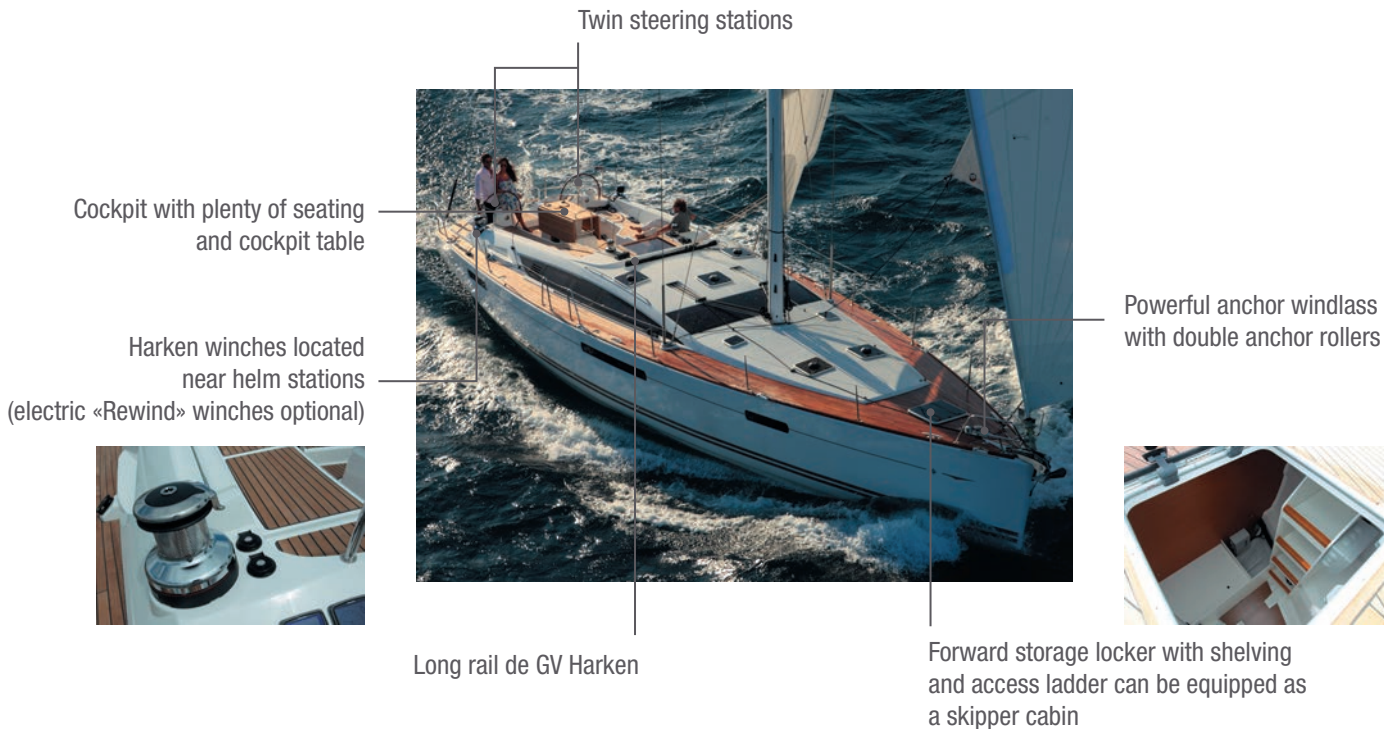

INTERIOR LAYOUTS

2 cabins version / 2 heads



4 cabins version / 4 heads



3 cabins version / 3 heads



5 cabins version / 3 heads



4 cabins version / 2 heads



SALOON

Seating with triple density foam for maximum comfort



Fold-out bar furnishings between lounge seats

Storage boxes under floor

Oak laminate flooring with dark stripes

CD player with speakers in saloon and waterproof speakers in cockpit

White Corian® insert

Room for 8

Table on electric pedestal can be converted to a coffee table (option)



Folding armchairs - Dedon Seax (option)

Large navigation desk with leatherette -lining and storage under nav seat

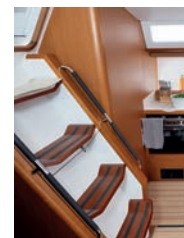

Wide companionway

GALLEY



Plenty of storage for offshore cruising including under floor storage



Top access icebox/ freezer (100L)

High-quality galley countertop

Soft-return drawers and waste bin designed for recycling

Fridge compartment (200L) with top and side access

Stainless steel galley blower with light (option)

3-burner stove with thermos-tatically controlled oven

FORWARD OWNER'S CABIN

Spacious and comfortable owner's cabin with leatherette-lined desk and large hanging locker (additional equipment available as options)



FORWARD OWNER'S CABIN (continued)

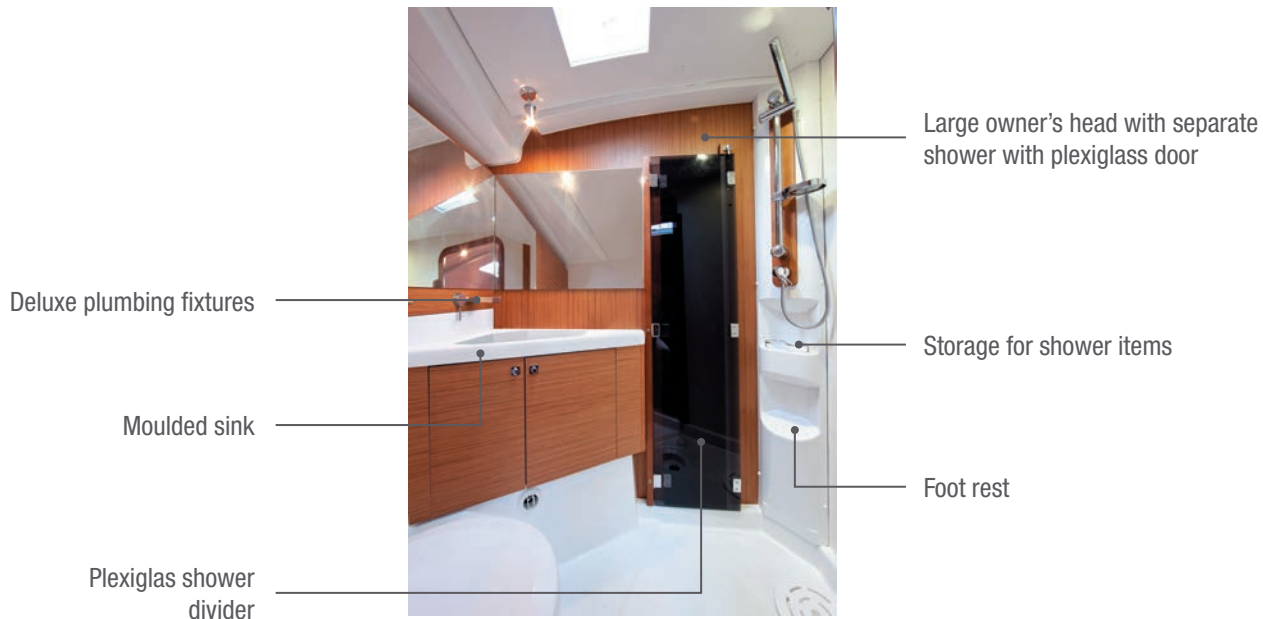

2 FORWARD CABINS

Removable bulkhead between cabins allows for transformation from 2 double berths into 1 suite (storage for bulkhead under berth)

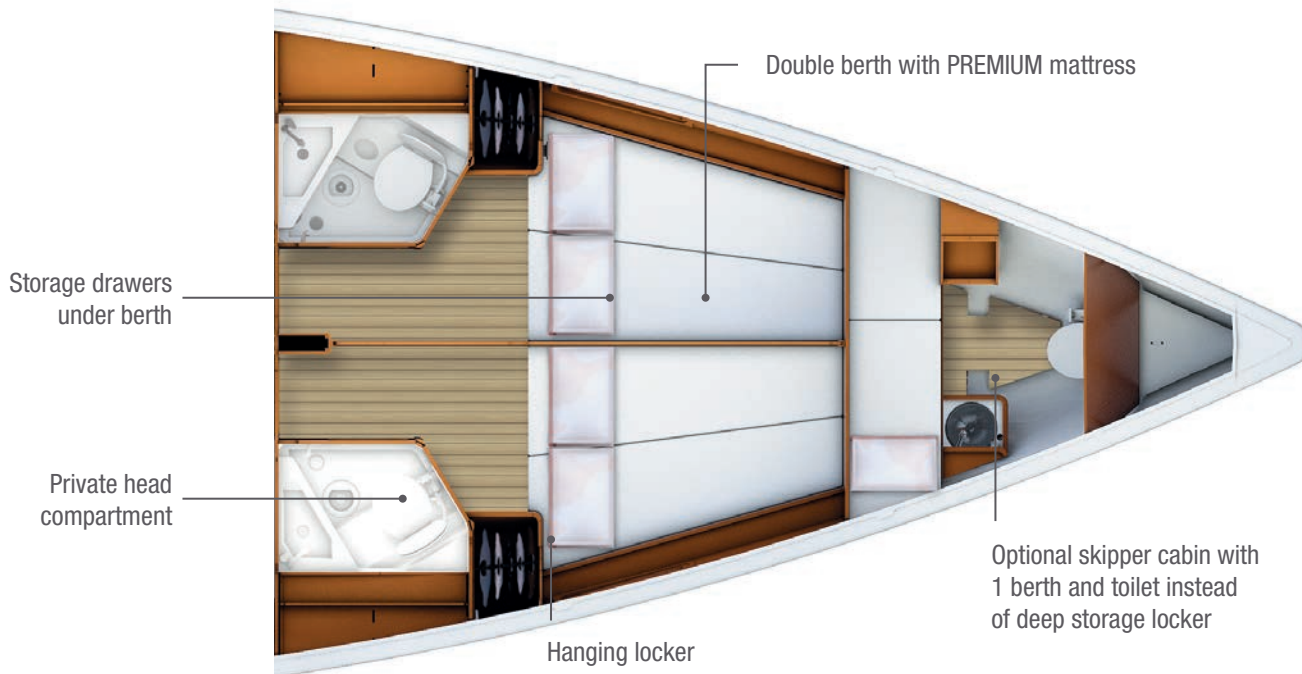

2 AFT CABINS

Domed ceiling in aft cabins with opening ports extends under the cockpit table and provides headroom, ventilation and light

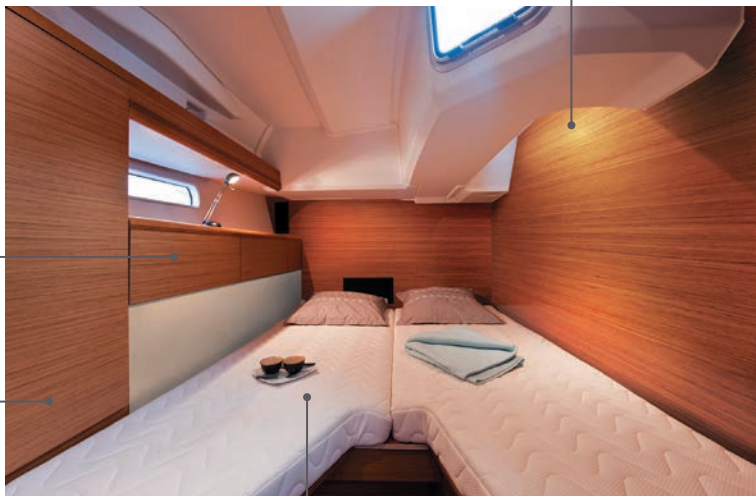

Closed cabinets

Hanging lockers for each cabin

2 double berths with PREMIUM mattress

Private head compartment with shower

2 aft cabins + 2 heads



2 aft cabins + 1 lateral cabin



AFT OWNER'S CABIN

Domed ceiling in aft cabins with opening ports extends under the cockpit table and provides headroom, ventilation and light

Indirect LED lighting

Headroom over the berth

Night stands to each side of the berth with chrome lamps



Double bed with PREMIUM mattress (optional inner-spring mattress available)

Seating to either side of the berth with back rests

Easy engine access

Owner's head compartment with separate plexiglass shower



Vanity area with desk and storage

Very large hanging locker

SAIL AND RIG PLANS: Sails for every sailor

Select the sail plan that best fits your style:

- **A very balanced sail plan** for maximum performance while limiting the loads on the sheets.
- **Inboard shrouds and genoa tracks** allow better trim of the standard or performance sails and easy circulation on the side decks.
- Furling mainsail available in Mylar or Dacron, as well as a classic mast option



SPECIFICATIONS

FURLING MAINSAIL :

- Dacron®
- Horizontal panels
- UV-stabilised thread
- Radial reinforcements
- Draft stripe
- Adjustable leech line
- UV protection at sheet attachment
- Area : 48,2 m²



LARGE OVERLAPPING FURLING GENOA (135%) :

- Dacron®
- Horizontal panels
- UV-stabilised thread
- Webbing strap at head
- Bolt-rope for furler
- Anti-UV protection on foot and leech
- Draft stripe
- Webbing strap at tack
- Reefing marks
- Adjustable leech line
- Area : 78,1 m²



ADVANTAGES

- Easy to handle sail plan
- Versatile and balanced sail plan at all sailing angles



I = 19,00 m / 62'4"
 J = 6,23 m / 20'5"
 P = 17,50 m / 57'4"
 E = 6,00 m / 19'8"

1- CLASSIC MAST - DACRON® SAILS

CLASSIC MAINSAIL : 61 m²

**CLASSIC GENOA
135% : 78,1 m²**

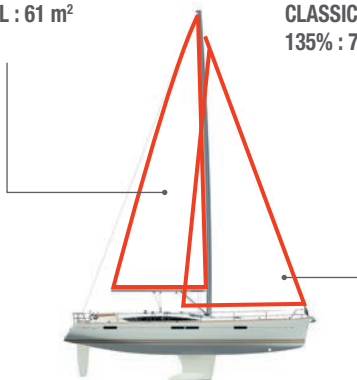

2- FURLING MAST - UPGRADE VOILES MYLAR

**MYLAR FURLING MAINSAIL :
48,2 m²**

**MYLAR GENOA 135% :
78,1 m²**

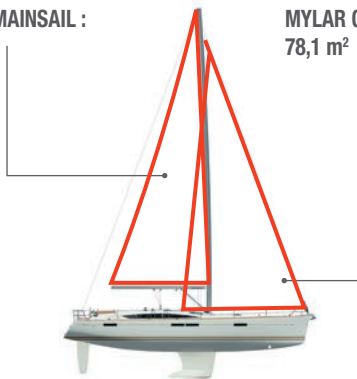

3- PERFORMANCE MAST - MYLAR SAILS

**MYLAR PERFORMANCE MAINSAIL :
67 m²**

**PERFORMANCE GENOA
MYLAR 125% : 75,4 m²**

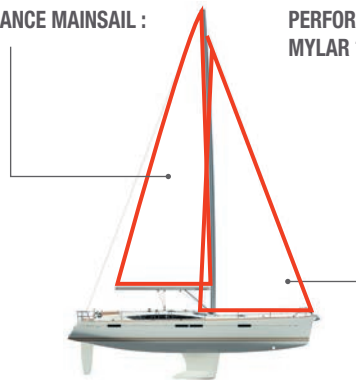

4- CODE 0

**FURLING MAST : 103 m²
PERFORMANCE MAST : 107 m²**



SPECIFICATIONS

BATTENED MAINSAIL :

- Dacron®
- Horizontal panels
- Stainless steel eyes
- UV-stabilised thread
- Draft stripe
- Radial reinforcements
- Adjustable leech line
- Loose-footed
- Full batten
- 2 reef points each with singleline reefing system.
(Third classic reef point)
- Replaces the standard mainsail
- Included in classic mast option
- Lazy bag included
- **Area : 61 m²**



ADVANTAGES

- Larger sail area
- A more powerful sail plan but still well-balanced

SPECIFICATIONS

LARGE OVERLAPPING GENOA (135%) :

- Dacron®
- Horizontal panels
- UV-stabilised thread
- Webbing strap at head
- Bolt-rope for furler
- Anti-UV protection on foot and leech
- Draft stripe
- Webbing strap at tack
- Reefing marks
- Adjustable leech line
- **Area : 78,1 m²**



PERFORMANCE SAILS : MYLAR TAFFETA X-GRID

Working in collaboration with Dimension-Polyant and Technique Voiles, Jeanneau has developed a new Mylar Taffeta X-Grid fabric for the Performance range.

The triradial construction of the sail contributes to superior shape holding, but other forces can act on the individual panels. By using a specially-designed X-Grid® of fibres angled at 6° laminated into the fabric, better bias control can be achieved which makes the sail more resistant to deformation and aging.

The performance of these new fabrics provides a more stable sail cloth that is lighter, easier to handle, with better shape control over time.

These new Performance sails are easily recognisable; they include a taffeta laminate that is light grey that gives them a very “hi-tech” look.

- 1 - Protective taffeta
- 2 - Polyester film
- 3 - X-Grid® fibres
- 4 - Polyester scrim

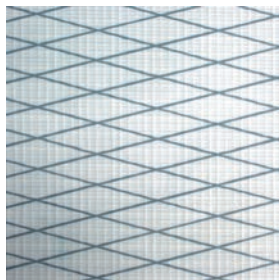

SPECIFICATIONS

FURLING MAINSAIL

Mylar :

- Mylar/taffeta X-Grid fabric in grey colour
- Triradial cut
- UV-stabilised thread
- Radial reinforcements
- Draft stripe
- Adjustable leech line
- UV protection at sheet attachment
- Replaces the standard mainsail
- **Area : 48,2 m²**

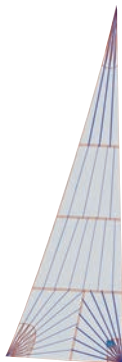

SPECIFICATIONS

LARGE OVERLAPPING FURLING MYLAR GENOA (135%) :

- Mylar/taffeta X-Grid fabric in grey colour
- Triradial cut
- UV-stabilised thread
- Webbing strap at head
- Bolt-rope for furler
- Anti-UV protection on foot and leech
- Radial reinforcements
- Draft stripe
- Webbing strap at tack
- Reefing marks
- Adjustable leech and foot lines
- Replaces the standard genoa
- **Area : 78,1 m²**



ADVANTAGES

- Sail plan geometry is identical to the standard sail plan providing the same balance, versatility and ease of handling
- High-end sail cloth material means less stretch and better performance
- Tri radial cut ensures better sail shape and improved resistance to wear.
- Balanced sail plan for all sailing angles
- Easy to use in all conditions

SPECIFICATIONS

FULL-BATTENED MYLAR PERFORMANCE MAINSAIL :

I Perf. = 19,70 m / 64'7"
 J = 6,23 m / 20'5"
 P. Perf. = 19,00 m / 62'4"
 E = 6,00 m / 19'8"

- Mylar/taffeta X-Grid fabric in grey colour
- Triradial cut
- Stainless steel eyes
- UV-stabilised thread
- Draft stripe
- Radial reinforcements
- Adjustable leech and foot lines
- Loose-footed
- Fibreglass battens
- 2 reef points each with singleline reefing system.
 (Third classic reef point)
- Replaces the standard mainsail
- Included in Tall mast option
- Lazy bag included
- **Area : 67 m²**

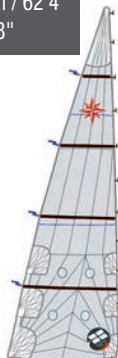

ADVANTAGES

- High-end sail cloth material means less stretch and better performance
- Tri radial cut ensures better sail shape and improved resistance to wear.
- Perfect for offshore sailing
- Powerful sailplan in lighter winds

SPECIFICATIONS

FURLING GENOA 125% Performance Mylar :

- Mylar/taffeta X-Grid fabric in grey colour
- Triradial cut
- UV-stabilised thread
- Webbing strap at head
- Bolt-rope for furler
- Anti-UV protection on foot and leech
- Radial reinforcements
- Draft stripe
- Webbing strap at tack
- Reefing marks
- Adjustable leech line
- Replaces the standard genoa
- Included in Tall mast option
- **Area : 75,4 m²**

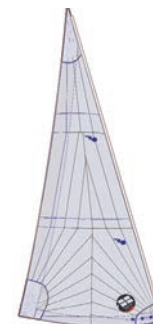

SPECIFICATIONS

CODE 0

Selden continuous line furler :

- Laminate Mylar/Aramid X-Grid fabric in light grey
- Triradial cut
- Anti twist luff cord
- UV-stabilised thread
- Straps for sheet attachment
- Adjustable leech and foot lines
- Requires rigging for asymmetrical spinnaker / Code 0
- **Area - furling mast : 103 m²**
- **Surface - performance mast : 107 m²**



ADVANTAGES

- A light wind sail designed for use between 60° and 120°
- Continue to sail when others have given up and turned on the motor
- Continuous line furler allows easy deployment and furling from the cockpit
- Ideal addition to boats with small overlapping jibs and self-tacking jibs

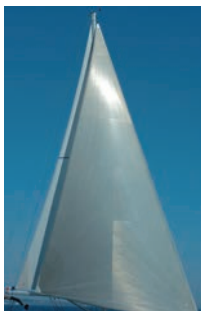

CODE 0: MYLAR ARAMID X-GRID

For the development of the new Code 0 sails on a continuous line furler, Jeanneau selected a sail cloth that is perfectly adapted for use in light airs. Highly resistant, light weight and able to be furled, the Mylar Aramid X-Grid has a light grey finish that is translucent.

Unidirectional Aramid fibres, vacuum-bagged together between two polyester films, provide an unequalled resistance to weight ratio. This ultra light sail is easy to handle and fills with the slightest puff of wind.

Adding the X-Grid® polyester fibres at a 6° angle provides excellent bias control in all directions and improves sail shaping, as well as, resistance to tearing.

Lastly, a taffeta is added to the external laminate of the sail cloth to protect the sail from ultraviolet light and wear during furling or storage.

The Code 0 sails from Jeanneau integrate these high-performance materials to meet the exacting demands of our owners. In addition to these high-end materials, the look of these sails sets Jeanneau apart.

- 1 - Polyester film
- 2 - X-Grid® fibres
- 3 - Unidirectional Aramid fibres
- 4 - Protective taffeta

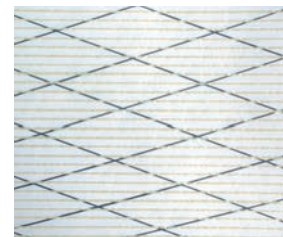
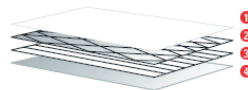



WHAT IS 360 DOCKING?

- The 360 Docking system is a revolutionary propulsion system developed by Jeanneau and ZF Marine. This unique system allows easy and safe manoeuvring of a sailboat in tight quarters via a joystick mounted in the cockpit.
- 360 Docking: Docking made easy!

DIFFERENT MODELS AVAILABLE

- The 360 Docking system has been developed in several different sizes in order to adapt it to sailboats from 40 to 57':

POD60 : 38' – 42'
 POD90 : 43' – 49'
 POD120 : 50' – 54'
 POD180 : 55' – 58'



HOW DOES IT WORK?

- The concept is simple: the engine is coupled with a pivoting sail drive, capable of rotating 360°
- The joystick transmits the commands to a control box, which uses the autopilot to lock the helm. Then, a simple movement of the joystick controls the orientation and the thrust of the pod, as well as the bowthruster when moving sideways
- You can vary throttle power with the joystick. You can also combine movements, like rotation and forward moment to turn and move forward at the same time.



> Forward movement: saildrive facing aft



> Sideways movement: saildrive turns 90° and activates bowthruster



> Aft movement: saildrive turns 180°



> Rotation: saildrive turns 90° to pivot boat around axis

UNIQUE FEATURES OF THE SYSTEM

- **Sideway manoeuvring:** manoeuvre in ways never before possible
- **Easy and powerful rotation:** using the saildrive leg at 90°, the boat can be rotated easily and quickly using the main engine, which is much more powerful than the bowthruster.
- **Very powerful reverse gear:** both with throttle and joystick due to the fact that the sail drive turns around 180° so that the propeller is always facing “forward.” This also means that folding propellers work very well with the system.
- **Ability to stop and adapt:** with the ability to move in any direction while applying variable power means that normal steerageway is not necessary for manoeuvring. The boat can be stopped, repositioned and moved at the touch of the joystick without having to do every manoeuvre at higher speeds. Safety and piece of mind.
- **Better visibility when manoeuvring:** most of our boats allow the helmsman to be standing when using the joystick so that he or she has a better view of the dock than if reaching down to use a traditionally-placed throttle control.
- **Comfort of an electronic throttle:** the regular throttle on the boat is electronic. This makes it easy to use.
- **Gearbox longevity:** since there is no reverse gear, the 360 Docking gearbox does not include any of the conical gears that typically wear out in standard gearboxes.

FAQ :

- **Is this system available from other boat manufacturers?**
The partnership between ZF Marine and the Groupe Beneteau means that only Jeanneau and Beneteau boats have access to this technology. Our exclusive agreement extends into 2014.
- **Can I use a folding propeller?**
Yes, folding propellers work very well with the system because the main drawback of folding propellers is that they don't work in reverse, but since the drive always rotates to face forward to the direction you want to go, the folding propeller works efficiently, even in reverse. We recommend Flex-o-Fold propellers.
- **Can I use a feathering (Max-Prop) propeller?**
No, there is no need to use a feathering propeller, as they are designed to rotate the blades when in reverse, so there is no clear advantage to installing these on a drive system with no reverse gear.
- **If, for some reason, there is a failure, can I rotate the saildrive manually?**
Yes, it can be rotated back into position manually in case of failure.



PRISMA PROCESS



Leader in vacuum bagging technology for the construction of racing boats, JTA developed an resin injection process applicable to the construction of cruising boats. By using advanced engineering, precisely positioned layers of glass fabric and mat and specially developed core materials, Jeanneau is able to mould a deck to exacting tolerances. Jeanneau's leadership in this domain gives it a substantial advantage over its competitors and ensures unequalled quality to the customer.

This 21st century technology allows Jeanneau to manufacture complex fibreglass parts with:

- Perfect finish on both sides (no need for a counter mould)
- Reduced weight (providing the sailboat better stability/performance)
- Increased strength and rigidity of the piece (quality of lay-up)
- Reduction by 90% of VOC emissions (environmentally-friendly)
- Optimum working conditions for the production team (no contact with resins/catalysts)
- High quality parts (precise control of gelcoat, core materials and resin injection)

The deck of the Jeanneau 53 is the largest mass-produced injection fibreglass part in the world.

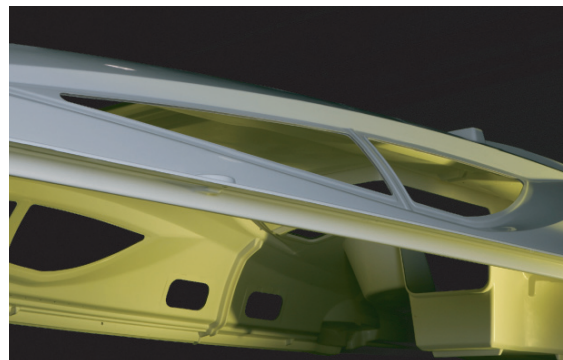

COUNTER-MOULDING

3rd generation hull structure

Jeanneau has long been known for strong and seaworthy boats. Today the technology of boatbuilding has evolved, but our commitment to this tradition has not wavered. The Jeanneau 3rd Generation Hull Structure combines the latest in fiberglass technology with modern yacht design to deliver a structural reinforcement perfectly adapted to the demands of the offshore sailor.

- ❶ High-load zones cut-out for access to the hull
- ❷ Integrated repair area at aft end of keel
- ❸ Structure is precisely placed in the hull
- ❹ Glued and relaminated to the hull for strength
- ❺ Acts as a support for the floorboards
- ❻ Keel bolts located near vertical members and through counter mould and hull
- ❼ Limber holes at hull level for efficient drainage
- ❽ Counter mould remains below level of floorboards and is not visible

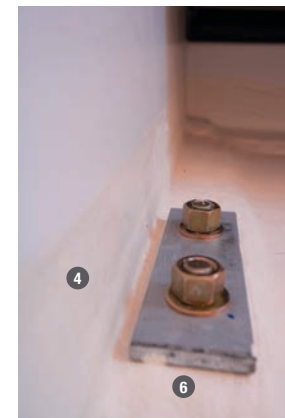

ALPI WOOD - FINETEAQ

SALES POINTS:

Environmental:

- Ayous (*Triplochiton scleroxylon* - Sterculiacées) trees in managed forests of indigenous hardwoods are selected and cut, with a constant care given towards long term preservation of natural resources.
- Teak and other soft rainforest woods often come from geopolitically sensitive regions and are not managed in a sustainable way.

Quality:

- These ALPI wood panels are substantially more expensive and reliable than standard marine plywood. They are used by top of the line furniture manufacturers, as well as many exclusive super-yacht builders (for example Azimut and Ferretti only use ALPI wood).
- Consistency of finish and colors throughout the boat.
- Elimination of “defects” in wood panels.

Durability:

- Harder finish that is more resistant to humidity
- Better resistance to UV
- Easier repairs as veneer is tinted through and through so clear varnishes can be used





BACKRESTS & SEATS

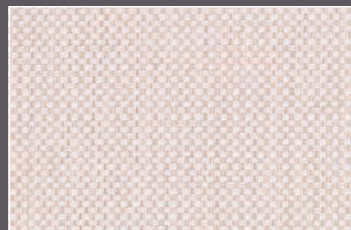

UPHOLSTERY leather
leatherette ▶ *Dark
graphite*

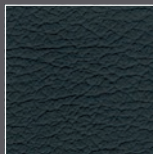

FLOOR
▶ *Standard*

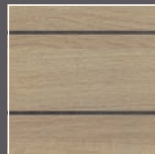

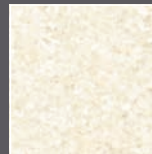

CARPET
▶ *Option*



Ambiance "WHITE GOLD" - Cabins

SEATS
▶ *White Gold*





HEAD BOARD
▶ *Ultraleather Brisa Birch*

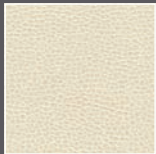

UPHOLSTERY leather leatherette
▶ *Dark graphite*

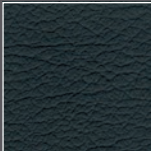

BEDS
▶ *Premium mattress*

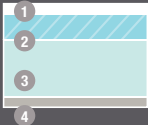

- 1- Removable mattress cover fabric with Ultra-Fresh® is anti-microbial, anti-bacterial and non-allergenic
- 2- Top: 40mm of High-Resilience foam
- 3- Base: 80mm of high-density polyether foam
- 4- Breathable fabric

▶ *Bed cover*



Infill cushion for convertible berth in White Gold fabric

Ambiance "MEDITERRANEO" - Saloon



BACKRESTS & SEATS

▶ *PVC Mediterraneo white*

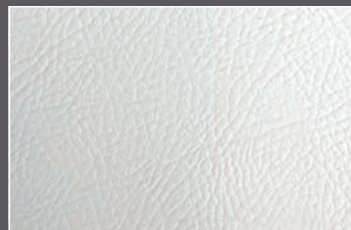

UPHOLSTERY leather
leatherette ▶ *Dark*
graphite

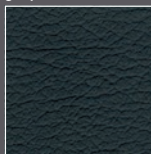

FLOOR
▶ *Standard*

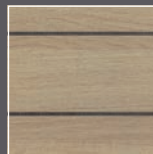

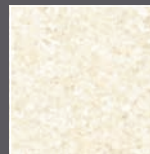

CARPET
▶ *Option*



Ambiance "MEDITERRANEO" - Cabins

SEATS
▶ *PVC Mediterraneo white*





HEAD BOARD
▶ *Ultraleather Brisa Birch*



UPHOLSTERY leather leatherette ▶ *Dark graphite*

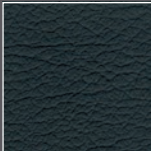

BEDS
▶ *Premium mattress*

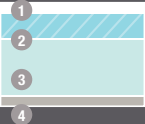

1- Removable mattress cover fabric with Ultra-Fresh® is anti-microbial, anti-bacterial and non-allergenic

2- Top: 40mm of High-Resilience foam

3- Base: 80mm of high-density polyether foam

4- Breathable fabric

▶ *Bed cover*



Infill cushion for convertible berth in White Gold

Ambiance "BRICKS HAVANA" - Saloon



BACKRESTS

▶ *Plana havana*

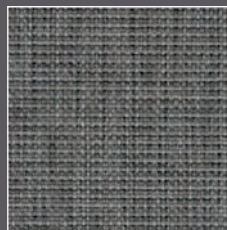

SEATS

▶ *Bricks havana*



**UPHOLSTERY leather
leatherette** ▶ *Dark
graphite*

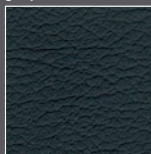

FLOOR

▶ *Standard*

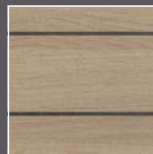

CARPET

▶ *Option*

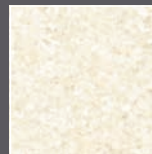

Ambiance "BRICKS HAVANA" - Cabins

SEATS
 ▶ *Bricks havana & Plana havana*

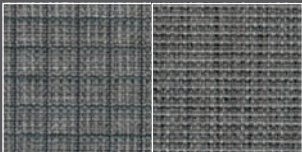

UPHOLSTERY leather leatherette ▶ *Dark graphite*

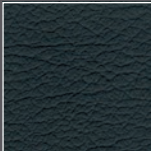

BEDS
 ▶ *Premium mattress*

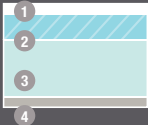

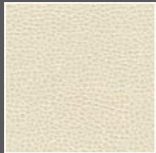

- 1- Removable mattress cover fabric with Ultra-Fresh® is anti-microbial, anti-bacterial and non-allergenic
- 2- Top: 40mm of High-Resilience foam
- 3- Base: 80mm of high-density polyether foam
- 4- Breathable fabric

HEAD BOARD
 ▶ *Ultraleather Brisa Birch*



▶ *Bed cover*

Infill cushion for convertible berth in White Gold

Ambiance "EXPRESSO" - Saloon



BACKRESTS & SEATS

▶ *Choco expresso*



UPHOLSTERY leather
leatherette ▶ *Dark*
graphite

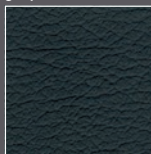

FLOOR
▶ *Standard*

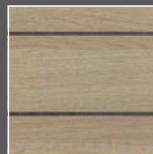

CARPET
▶ *Option*

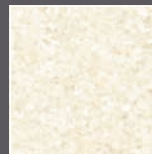

SEATS
▶ *Choco expresso*





HEAD BOARD
▶ *Ultraleather Brisa Birch*



UPHOLSTERY leather leatherette ▶ *Dark graphite*

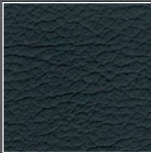

BEDS
▶ *Premium mattress*

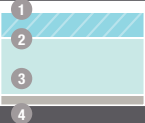

1- Removable mattress cover fabric with Ultra-Fresh® is anti-microbial, anti-bacterial and non-allergenic

2- Top: 40mm of High-Resilience foam

3- Base: 80mm of high-density polyether foam

4- Breathable fabric

▶ *Bed cover*



Infill cushion for convertible berth in White Gold



BACKRESTS & SEATS

▶ *Libeco souris*

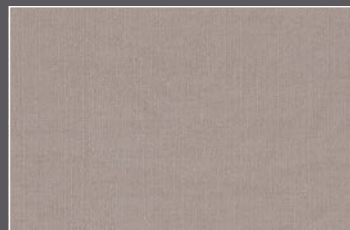

UPHOLSTERY leather
leatherette ▶ *Dark*
graphite

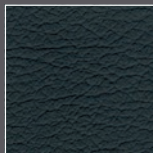

FLOOR
▶ *Standard*

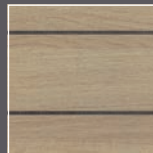

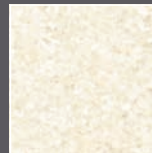

CARPET
▶ *Option*



Ambiance "LINEN" - Cabins

SEATS
▶ *Libeco souris*





HEAD BOARD
▶ *Ultraleather Brisa Birch*

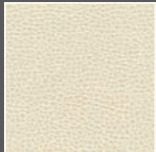

UPHOLSTERY leather leatherette ▶ *Dark graphite*

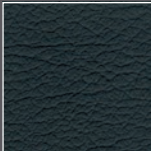

BEDS
▶ *Premium mattress*

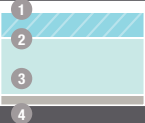

1- Removable mattress cover fabric with Ultra-Fresh® is anti-microbial, anti-bacterial and non-allergenic

2- Top: 40mm of High-Resilience foam

3- Base: 80mm of high-density polyether foam

4- Breathable fabric

▶ *Bed cover*



Infill cushion for convertible berth in White Gold

Ambiance "LEATHER" - Saloon



BACKRESTS & SEATS ▶ *Leather - 8 colors available- See fabric samples*



UPHOLSTERY leather
leatherette ▶ *Dark graphite*

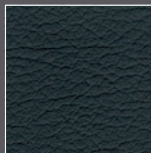

FLOOR
▶ *Standard*

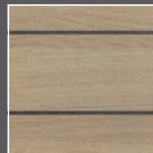

CARPET
▶ *Option*

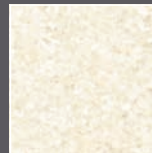

Ambiance "LEATHER" - Cabins

SEATS ▶ *Leather - 8 colors available- See fabric samples*



UPHOLSTERY *leather leatherette* ▶ *Dark graphite*

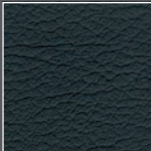

BEDS
▶ *Premium mattress*

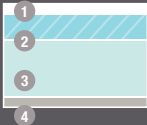

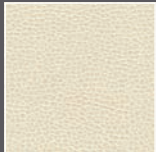

- 1- Removable mattress cover fabric with Ultra-Fresh® is anti-microbial, anti-bacterial and non-allergenic
- 2- Top: 40mm of High-Resilience foam
- 3- Base: 80mm of high-density polyether foam
- 4- Breathable fabric

HEAD BOARD
▶ *Ultraleather Brisa Birch*



▶ *Bed cover*

Infill cushion for convertible berth in White Gold

EXTERIOR UPHOLSTERY

SPRAYHOOD PROTECTION BIMINI / LAZY BAG



Beige tweed

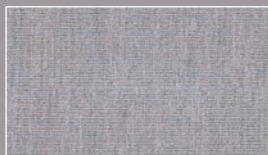

COCKPIT CUSHIONS



Backrests: beige stripe

Seats: beige tweed

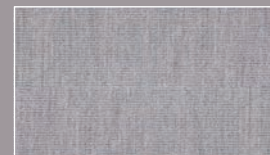
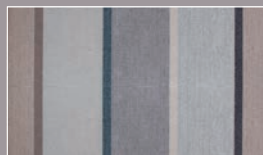

Raymarine

Electronic Pack

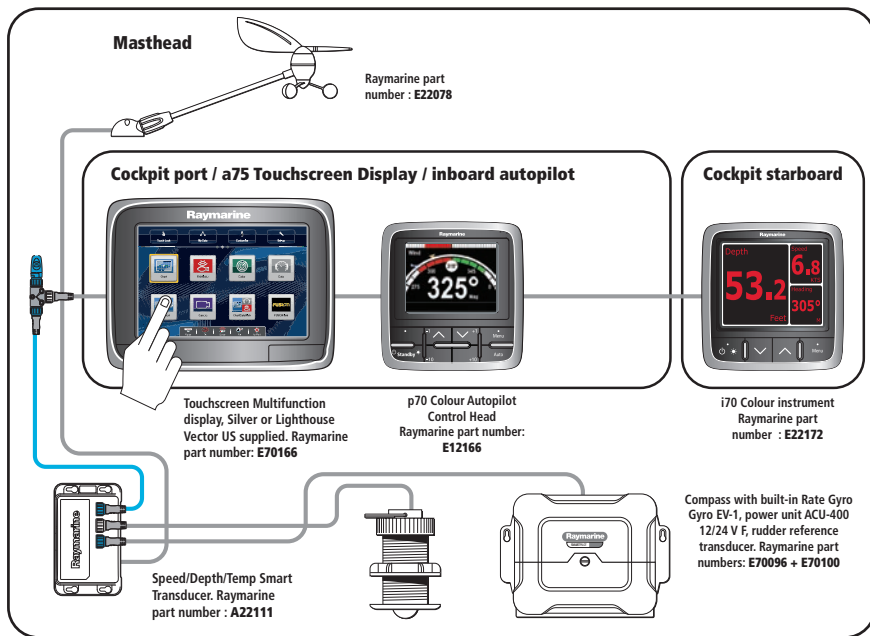

OPTIONS 1/2

e125 Multifunction Touchscreen Display WXGA 1280 x 800 pixels at the chart table



Touchscreen Multifunction display, Silver or Lighthouse Vector US supplied
Raymarine part number: E70023



a75 Multifunction Touchscreen Display Cockpit starboard



Touchscreen Multifunction display, Silver or Lighthouse Vector US supplied
Raymarine part number: E70166



Raymarine

OPTIONS 2/2

HD Digital Radar radome antenna 48 NM 18"



HD DIGITAL radar antenna supplied with antenna cable and mast bracket.
Raymarine part number: **E92142**

SmartController Wireless remote



Raymarine part number:
E15023

PC interface



SeaTalkng to NMEA0183 interface bridge for PC.

Image of the GPS display on the TV in the main saloon



2 way control between the Multifunction display and your mobile device.
Application to download from the App Store, Google Play or the Amazon Store.
Require a Smartphone or a tablet not supplied.

Fix mounted DSC VHF Radio & Class B AIS transceiver (Works only if a e series screen is fitted)



VHF DCS Ray55E
Raymarine part number : **E43037**
Compatible with a second stantion handset (Not supplied)



AIS650 class B AIS transceiver
Receive and transmit AIS navigation status information on e series. Use the VHF antenna.
Raymarine part number : **E32158**

